

ASISTAL

GILJOTINE G100T

VERTIKALNO KLIZNI SISTEM

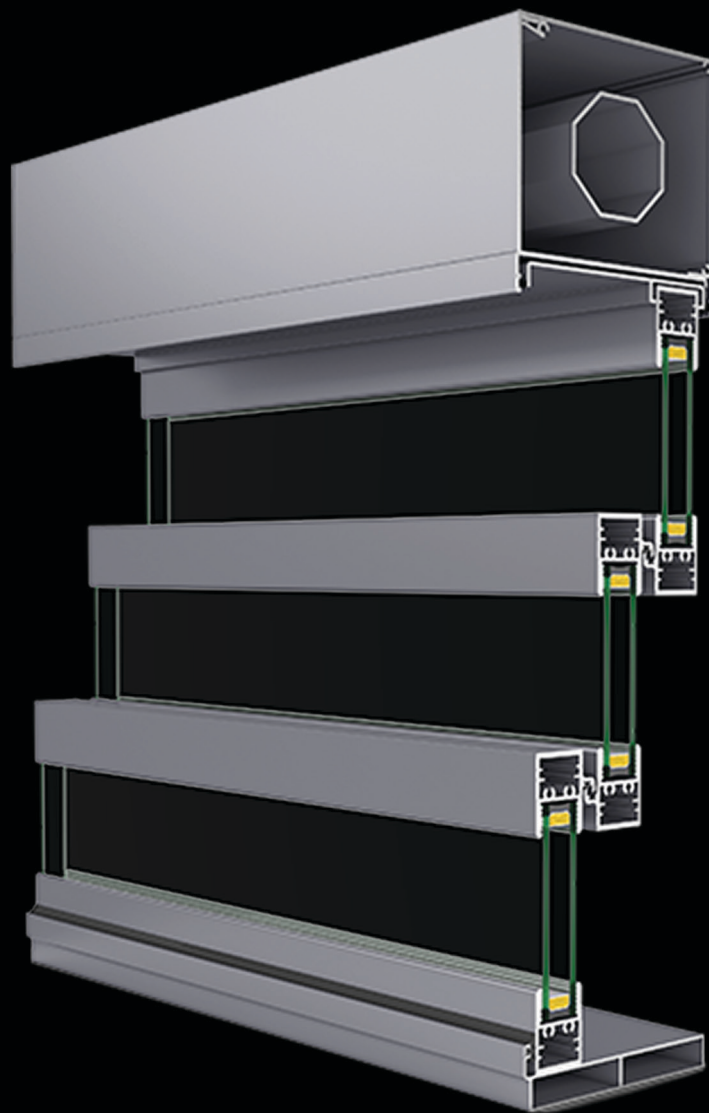

GILJOTINE G100T - VERTIKALNO KLIZNI SISTEM

Prikazane cene su izražene u evrima sa uračunatim PDV-om od 20%

G100T 02R Spoljni pokrivni profil za motor

142.9mm/151.5mm
L=6000mm

SIROVO

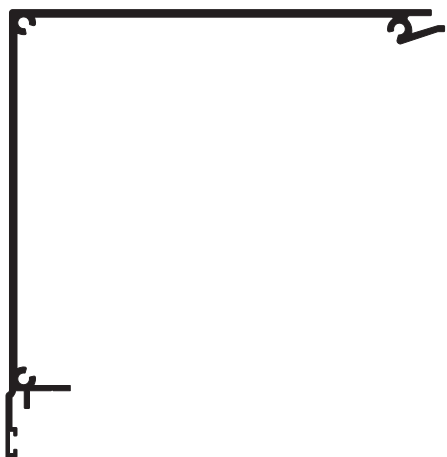

113.00€

G100T 03R Unutrašnji pokrivni profil za motor

144.3mm/151.5mm
L=6000mm

SIROVO

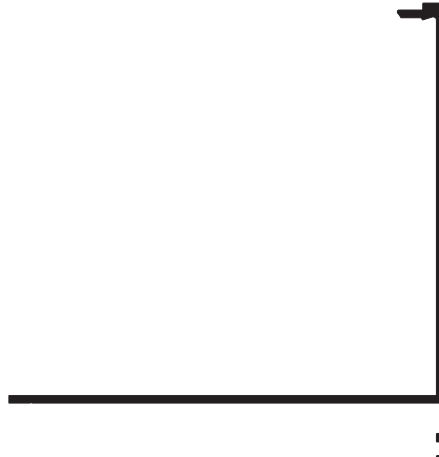

113.00€

G100T 04 Završni pokrivni profil krila

136.5mm/14mm
L=6000mm

SIROVO



47.00€

G100T 06 Donji horizontalni profil

140.4mm/38mm
L=6000mm

SIROVO



73.00€

G100T 01 Vodilica

79mm/68.2mm
L=6000mm

SIROVO

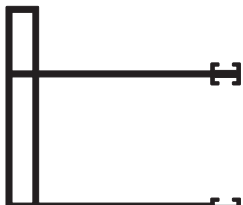

80.00€

G100T 05 Pokrivni profil vodilice

45.5mm/7.4mm
L=6000mm

SIROVO



9.00€

G100T 07 Adapter za jednostruko staklo

26.8mm/19.8mm
L=6000mm
Za ispunu 8mm

SIROVO



19.00€

G100T 11 Krilo

33.8mm/47.5mm
L=6000mm
Za ispunu 24mm

SIROVO

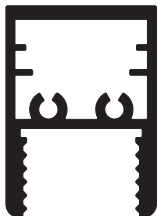

64.00€

G100T 12 Preklopno krilo

43.4mm/47.5mm
L=6000mm
Za ispunu 24mm

SIROVO

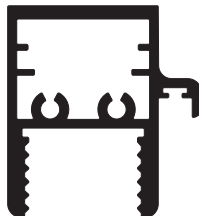

69.00€

G100-A1 Motor

Becker
Made in Germany
1 kom



405.00€

G100-A2 Daljinski upravljač

Becker
Made in Germany
1-kanalni
1 kom



65.00€

G100-A3 Daljinski upravljač

Becker
Made in Germany
5-kanalni
1 kom



88.00€

G100T-A4 Zupčanik

1 kom

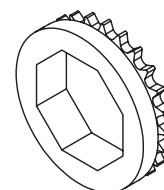

12.00€

GILJOTINE G100T - VERTIKALNO KLIZNI SISTEM

Prikazane cene su izražene u evrima sa uračunatim PDV-om od 20%

G100T-A6 Lanac



1 kom
L=5000mm

56.00€

G100-A11-1 Vodilica za lanac

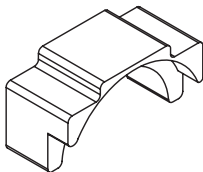

1 kom

1.50€

G100-A11-2 Plastični ležaj

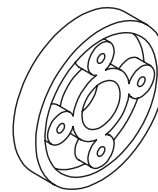

1 kom

1.00€

G100-A11-3 Adapter zupčanika

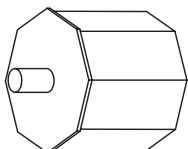

1 kom

3.50€

G100-A11-4 Roler

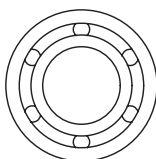

1 kom

1.00€

G100T-A1 Bočni poklopci motora

Par

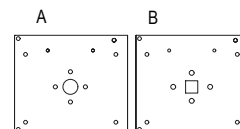

9.00€

G100T-A2 Gornja spojnica



1 kom

2.50€

G100T-A3 Spojnica krila

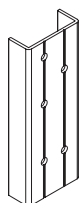

1 kom

2.50€

EM-G100-A4 Poklopac za G100T 04

Par

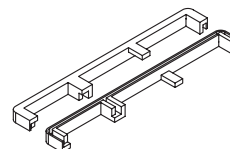

0.50€

220-63-000-00 Guma krila

L=200m



50.00€

200-06-860-00 Guma

L=90m



40.00€

BZXPB-67.550 Četkica

6.7×5.5 mm
L=350 m



42.00€

BZXPB-67.600 Četkica

6.7×6 mm
L=350 m



49.00€

G100-A12 Galvanizovan profil

L=4500 mm

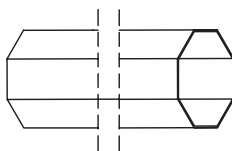

38.00€

GILJOTINE G100T - VERTIKALNO KLIZNI SISTEM

Prikazane cene su izražene u evrima sa uračunatim PDV-om od 20%

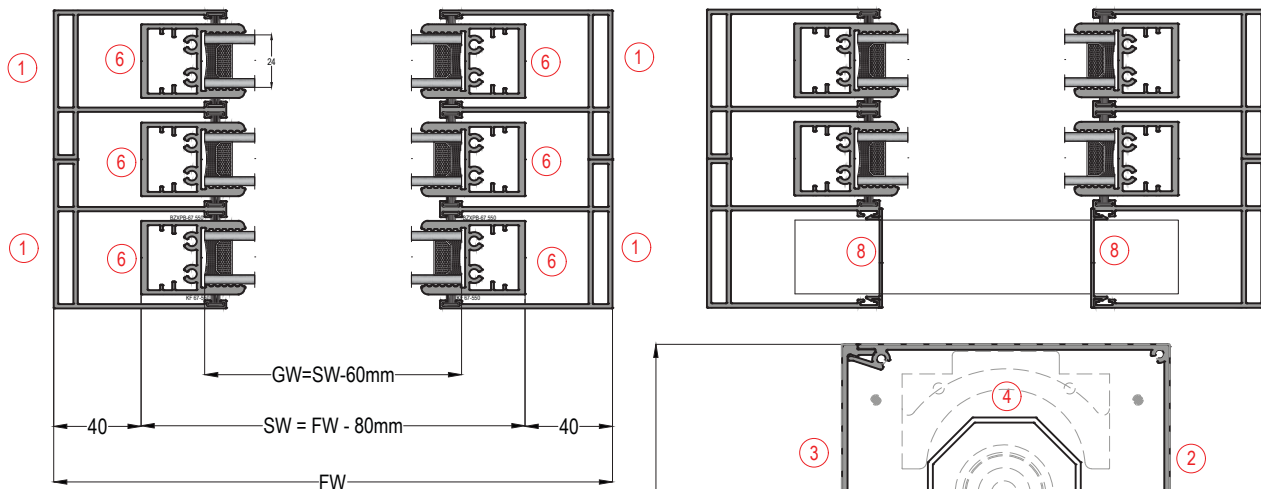

Maksimalna širina 4500 mm, maksimalna visina 3000 mm

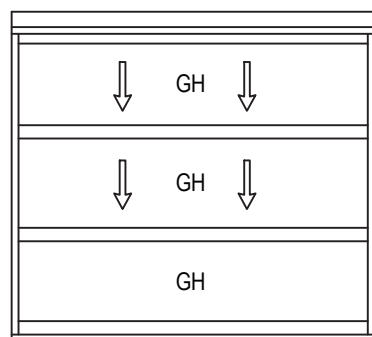

(Širina kriła) SW = FW - 80mm
(Visina kriła) SH = (FH - 62.2mm) / 3

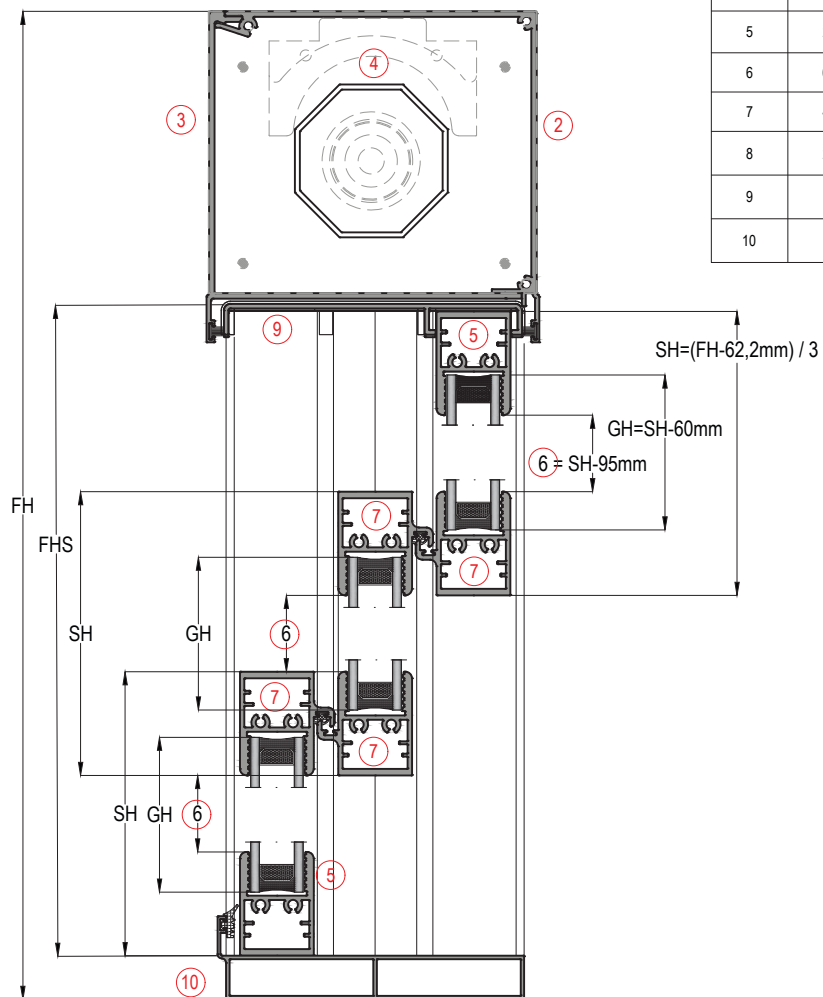

DIMENZIJE REZANJA I PRIBOR

PROFILI					
Redni broj	Kom	Šifra	Crtež	Naziv	Dimenzije rezanja
1	4	G100T 01		Vodilica	FHS = FH - 152mm
2	1	G100T 02 R		Spoljni pokrivni profil za motor	FW - 6mm
3	1	G100T 03R		Unutrašnji pokrivni profil za motor	FW - 6mm
4	1	G100 A12		Galvanizovan profil	FW - 40mm
5	2	G100T 11		Horizontalno kriło - gornje i donje	FW - 80mm
6	6	G100T 11		Vertikalno kriło	SH - 95mm
7	4	G100T 12		Horizontalno preklapno kriło	FW - 80mm
8	2	G100T 05		Pokrivni profil vodilice	FHS - SH
9	1	G100T 04		Završni pokrivni profil kriła	FW - 175mm
10	1	G100T 06		Donji horizontalni profil	FW

PRIBOR			
Kom	Šifra	Izgled	Naziv
1 kom	G100-A1		Motor
* 1 kom	G100 - A2		Daljinski upravljač 1-kanalni
* 1 kom	G100 - A3		Daljinski upravljač 5-kanalni
2 kom	G100T - A4		Zupčanik
2 kom	G100T - A6		Lanac
1 kom	G100T - A1		Bočni poklopci motora
2 kom	G100 - A11-1		Vodilica za lanac
1 kom	G100 - A11-2		Plastični ležaj
1 kom	G100 - A11-3		Adapter zupčanika
1 kom	G100 - A11-4		Roler
2 kom	G100T-A2		Gornja spojnica
10 kom	G100T-A3		Spojnica kriła
1 set	EM-G100-A4		Cover For G100T 04
((4X(FHS-SH))+ (4X(FHS-(2XSH))))	BZXPB-67.550		Četkica 5.5 mm
2XFW	BZXPB-67.600		Četkica 6 mm
2XSW	220-63-000-00		Guma za kriło
FW	200-06-860-00		Guma

* MOŽETE IZABRATI JEDAN OD NJIH

GILJOTINE G100T - VERTIKALNO KLIZNI SISTEM

Prikazane cene su izražene u evrima sa uračunatim PDV-om od 20%

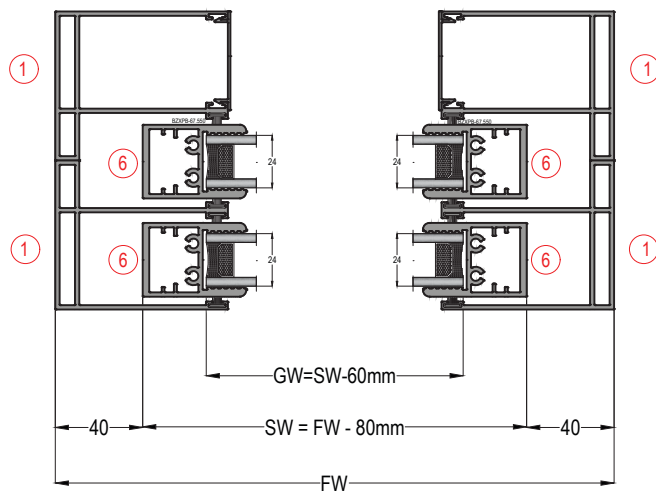

Maksimalna širina 4500 mm, maksimalna visina 3000 mm

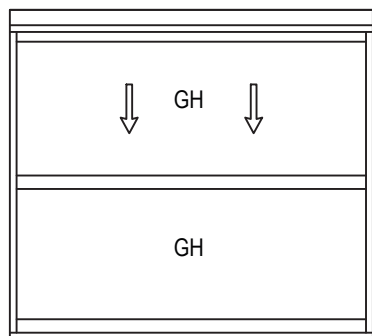

(Širina krila) SW = FW - 80mm
(Visina krila) SH = (FH - 110mm) / 2

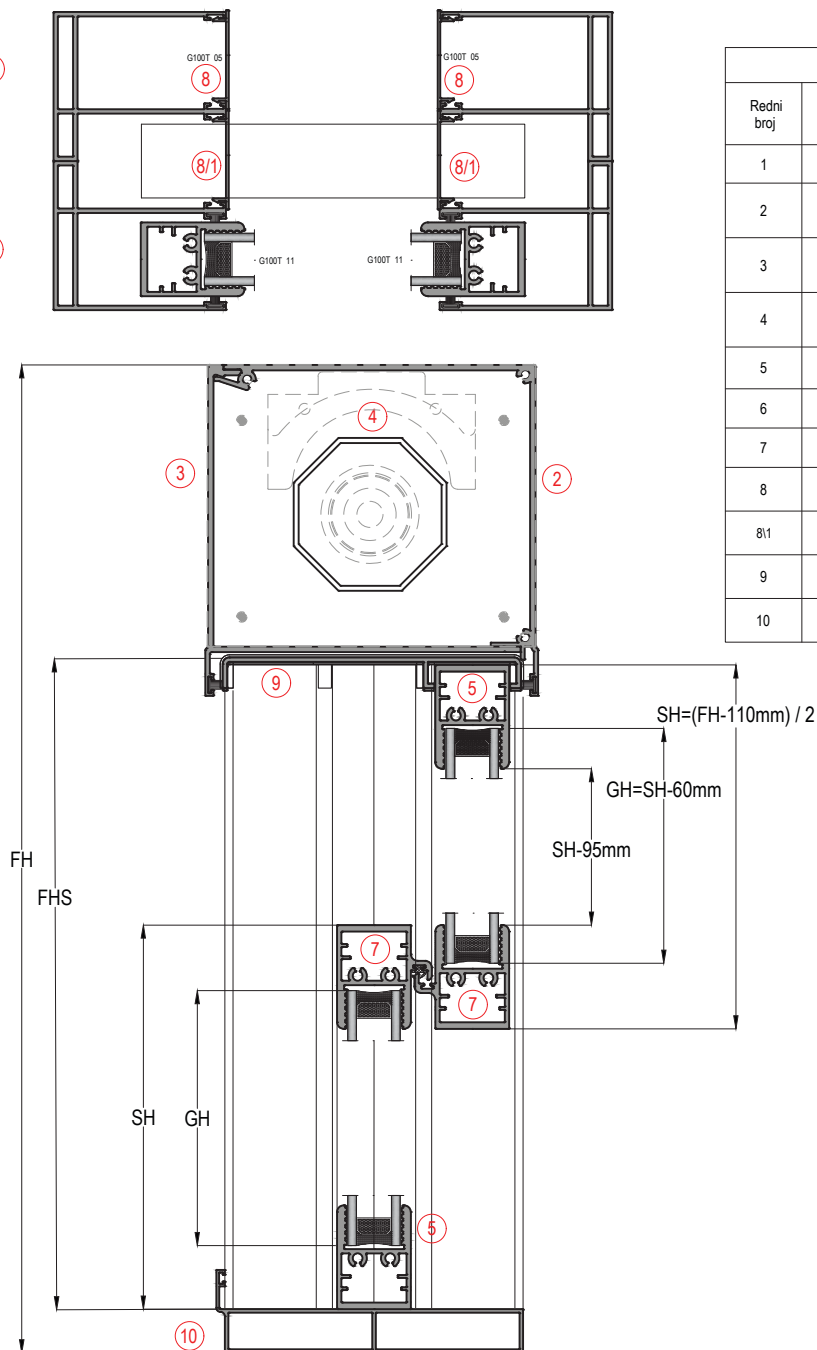

DIMENZIJE REZANJA I PRIBOR

PROFILI					
Redni broj	Kom	Šifra	Profil	Naziv	Dimenzije rezanja
1	4	G100T 01		Vodilica	FHS = FH - 152mm
2	1	G100T 02 R		Spoljni pokrivni profil za motor	FW - 6mm
3	1	G100T 03 R		Unutrašnji pokrivni profil za motor	FW - 6mm
4	1	G100 A12		Galvanizovan profil	FW - 40mm
5	2	G100T 11		Horizontalno krilo - gornje i donje	FW - 80mm
6	4	G100T 11		Vertikalno krilo	SH - 95mm
7	2	G100T 12		Horizontalno preklopno krilo	FW - 80mm
8	2	G100T 05		Pokrivni profil vodilice	FHS
8/1	2	G100T 05		Pokrivni profil vodilice	FHS - SH
9	1	G100T 04		Završni pokrivni profil krila	FW - 175mm
10	1	G100T 06		Donji horizontalni profil	FW

PRIBOR			
Kom	Šifra	Izgled	Naziv
1 kom	G100-A1		Motor
*1 kom	G100 - A2		Daljinski upravljač 1-kanalni
*1 kom	G100 - A3		Daljinski upravljač 5-kanalni
2 kom	G100T - A4		Zupčanik
2 kom	G100T - A6		Lanac
1 kom	G100T - A1		Bočni poklopci motora
2 kom	G100 - A11-1		Vodilica za lanac
1 kom	G100 - A11-2		Plastični ležaj
1 kom	G100 - A11-3		Adapter zupčanika
1 kom	G100 - A11-4		Roler
2 kom	G100T-A2		Gornja spojnica
6 kom	G100T-A3		Spojnica krila
1 set	EM-G100-A4		Cover For G100T 04
(4X(FHS-SH))+ (4XFHS)	BZXPB-67.550		Četkica 5.5 mm
2XFW	BZXPB-67.600		Četkica 6 mm
2XSW	220-63-000-00		Guma za krilo
FW	200-06-860-00		Guma

* MOŽETE IZABRATI JEDAN OD NJIH