

 Made in Germany since 1923



ORIGINAL
LÖWE



LÖWE cutters 2018

for professional use

Every cut matters > [original-lowe.com](https://www.original-lowe.com)

ORIGINAL
We **LOVE** you



GREETING

Dear customers, business partners and friends of our Original LÖWE shears,

back in 1923, my grandfather Walther Schröder came up with a pioneering invention – he designed and patented the world’s first anvil pruning shears. Under the name of LÖWE 1, the updated design of these original pruning shears remains part of our range to this day, and indeed is still one of the most popular of all LÖWE pruning shears.

Ever since then, the Original LÖWE principle of a drawing cut against a firm and solid base has been continuously refined. It is still a feature of many LÖWE pruning shears and remains unsurpassed in terms of performance.

Today, we produce a wide range of anvil pruning shears and bypass pruning shears for professional use in viticulture, horticulture and fruit growing, as well as for many industrial applications under the Original LÖWE brand name.

The on-going development and manufacturing of our products stand at the core of our business. Here the very high quality of our shears forms the basis. So we manufacture all parts without exception in our Kiel plant – Made in Germany.

Throughout the world Original LÖWE is the trusted partner for dealers and users alike. Many years of cooperation with sales partners have been very important to me and my whole team. Professionals throughout the world have appreciated the quality of LÖWE pruning shears for over 90 years, in more than 90 countries.

I hope you enjoy dipping into the Original LÖWE world of cutters – as every cut matters!



Randolph Schröder
Managing Director
Gebr. Schröder GmbH · Kiel

INDEX

CUTTERS FOR AUTOMOTIVE MANUFACTURING	Page 34
CUTTERS FOR CARPENTERS	Page 18
CUTTERS FOR DRAINAGE TECHNOLOGY	Page 44
CUTTERS FOR ELECTRICAL INSTALLERS	Page 28
CUTTERS FOR FLOOR LAYERS	Page 10
CUTTERS FOR HEATING AND SANITATION	Page 36
CUTTERS FOR THE LEATHER INDUSTRY	Page 38
CUTTERS FOR PAINTERS AND UPHOLSTERERS	Page 42
CUTTERS FOR SAIL MAKERS/ADVERTISING TECHNICIANS	Page 40
CUTTERS FOR SCALE MODELING	Page 32
CUTTERS FOR TILERS	Page 14
CUTTERS FOR WINDOW BUILDING	Page 22
CUTTERS FOR WORKSHOP INSTALLATION	Page 46
CUTTERS AND SPARE PARTS	Page 48
PROMOTION MATERIALS	Page 67



ORIGINAL LÖWE – OUR GUIDING PRINCIPLE

WHAT DO WE DO?



WE MANUFACTURE AND SELL ORIGINAL LÖWE CUTTERS AND PRUNING SHEARS WORLDWIDE

WHAT IS IMPORTANT TO US?

TECHNOLOGY LEADER: THE BEST SHEARS COME FROM US

- » Greatest durability
- » Most suitable for the intended purpose
- » Best price-performance ratio

PARTNERSHIP WITH CUSTOMERS AND SUPPLIERS

- » Honest, open and trusting interaction with business partners
- » Top quality for all customers
- » Fair prices
- » Adherence to delivery schedules

SATISFIED EMPLOYEES

- » Appreciation and open interaction between colleagues
- » Ergonomic design of work stations to ensure the absence of physical and mental strain
- » Learn about work and business processes
- » Show an interest in problems
- » Coaching, external counselling

MODERN AND EFFICIENT PRODUCTION

- » Balance between automation and manual labour
- » Optimised material flow
- » Good communication with each other

GOOD DEEDS, SOCIAL COMMITMENT

- » Drachensee foundation
- » Plan Projekt
- » Ronald McDonald Haus
- » Kiel macht Mittag
- » Assumption of daycare and nursery school costs of employees' kids



SCAN AND LEARN MORE ABOUT US

HOW WE MAKE OUR CUTTERS ORIGINAL LÖWE – MADE IN GERMANY

Original LÖWE pruning shears stand for durability, robustness and straightforward design. They are characterised by practical details, maximum efficiency and extreme durability in everyday use, even when temperatures drop below freezing. Every component in a pair of Original LÖWE pruning shears is designed, produced and assembled in Germany by specially trained personnel.

The steel used in Original LÖWE blades is made to our own specifications in a German steelworks. The combination of this unique steel alloy and a hardening process tailored to its precise characteristics gives the blades their unrivalled strength. The latest CNC grinding machines coupled with

precision hand grinding give LÖWE blades their outstandingly sharp cutting edge, while continuous quality control of all components, throughout the entire production process, ensures the absolute reliability of our pruning shears.

A wide array of factors thus come together to create our unique cutting tools, which are the instruments of choice for professional users all around the world.

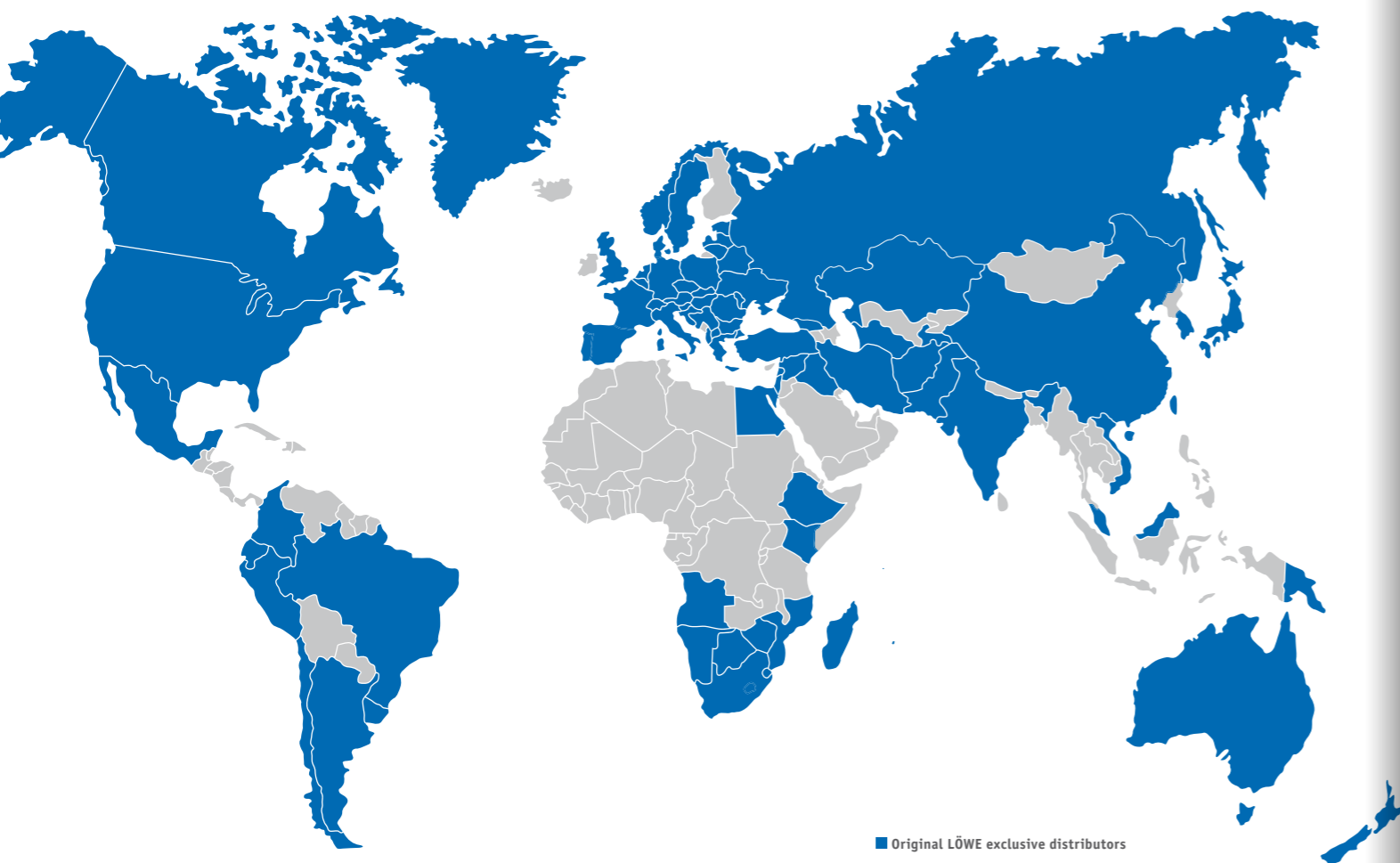

■ Original LÖWE exclusive distributors

ORIGINAL LÖWE INTERNATIONAL DISTRIBUTORS

Our international distributors and encouraged dealers take good care for a worldwide availability of our products in more than 90 countries, providing our Original LÖWE products – top class pruners, loppers and cutting tools.

Please find the contacts in alphabetical order per country on our website:

www.original-loewe.com/distribution-partners.



SCAN AND FIND YOUR DISTRIBUTION PARTNER OUT OF OVER 90 COUNTRIES WORLDWIDE.



Certified as an AEO (Authorised Economic Operator)

Authorised Economic Operators are particularly reliable and trustworthy international merchandise management partners. Certification stands for high standards of quality and safety and a transparent corporate culture founded on trust.

COMPANY IDEALS AND SOCIAL RESPONSIBILITY

Social encouragement for us means to be aware of the responsibility towards the community, getting active and giving support to other organizations which are doing social engaged practical work, too.

To us it lies at the heart supporting local and international projects at the same time as well as we care for our employees. Our company is future orientated conducting a sustainable growth with regard to society and environment.



Drachensee foundation

For many years we cooperate with the Drachensee Foundation (Stiftung Drachensee). The Drachensee Foundation is one of the biggest social institutions in the province of Schleswig-Holstein that provides a differentiated choice to people with disabilities. The institution offers 620 recognized workshop places at three locations in Kiel. In the department for metal working approximately 80 employees assemble Original LÖWE pruning shears and cutters for industry and trade.



Ronald McDonald House Kiel

The Ronald McDonald House in Kiel is a beautiful villa made of red brick, which provides a temporary home to families with seriously ill children. While the diseased children are treated in the neighboring University Hospital, their families live in one of the apartments of the house and can accompany the treatment at close range.

Since 2012 we sponsor the apartment no. 5 in the Ronald McDonald House in Kiel. Consistently we have positive experiences in which families and their children will be helped and our social commitment becomes a matter of the heart.



Plan International Deutschland e.V.

Since 2006, we have assumed sponsorships for children in Africa, Asia, Central and South America. Today we support a total of 40 children. Plan's vision is of a world in which all children realise their full potential in societies that respect people's rights and dignity.

Through our sponsorship at Plan we want to help that children grow up healthy and develop freely. We offer our sponsored children the chance of an education, medical assistance and participate with joy in their development.



Eco-power certificate

Since 2012, we get our power completely from renewable energy sources. In this case the power generation takes place in alpine water power stations at 100%. Neither climate-damaging CO₂ emissions, nor nuclear waste or other pollution emerge.

Here, too, with this decision our company accepts the responsibility for our environment, human being and nature.



Mach Mittag

„Mach Mittag“ [Make lunch] is a campaign of the „Stiftung Bildung macht stark“ [„Learning makes you stronger“ foundation].

The foundation was established in 2011 in order to fill a need for subsidising the financing of hot meals at school. The costs for a warm meal at school are subsidised for children who are eligible for the voucher so that the meal costs only one Euro. However, many families in Kiel cannot afford one Euro. Now „Mittagspaten“ assists with financing. Original LÖWE permanently supports 40 children per month.



Raceyard

We sponsor the Formula Student Team „Raceyard“ of the Kiel University of Applied Sciences. In this project, students work in a team building a single-seat race car with electric motor and then compete with other teams from around the world. The winning team does not necessarily have the fastest car, rather the best overall package.



Furthermore we support various youth sports divisions in our regional area and contribute with this support to healthy activity and sporty society.

EXAMPLE OF USE



LÖWE 5.105
Small anvil cutter
25 mm length of cut

Page 66



LÖWE 1.105
Anvil cutter
40 mm length of cut

Page 49



LÖWE 3.105
Anvil cutter
50 mm length of cut

Page 50



LÖWE 3.305
Anvil cutter
75 mm length of cut

Page 54



LÖWE 3.101
Mitre cutter
with stop faces at 45°
50 mm length of cut

Page 50



LÖWE 3.104
Mitre cutter
with stop faces at 45°
50 mm length of cut

Page 50



LÖWE 3.804
Mitre cutter
with trapezoidal blade
with stop faces at 45°
50 mm length of cut

Page 59



LÖWE 3.104/HU
Mitre cutter
with leverage
with stop faces at 45°
50 mm length of cut

Page 52



LÖWE 3.306/HU
Slat cutter
with leverage
with stop faces at 90°
75 mm length of cut

Page 55



LÖWE 3.806
Flat ribbon cable cutter
with trapezoidal blade
with stop faces at 90°
50 mm length of cut

Page 59



LÖWE 3.604
Cable duct cutter
with stop faces at 45°
75 mm length of cut

Page 56



LÖWE 3.605
Cable duct cutter
without stop faces
75 mm length of cut

Page 56



LÖWE 3.204/16u19
Tube cutter
Ø 16 mm and 19 mm

Page 53



LÖWE 3.204/P90
Tube and hose cutter
Ø max. 32 mm

Page 53



LÖWE 5.104/P90
Tube and hose cutter
small version
Ø max. 15 mm

Page 65



LÖWE 5.504
Hose cutter
with triangular blade
Ø max. 28 mm

Page 66



LÖWE 4.104/VR
Cutter for sealing profiles
at windows and doors V-cut,
for cutting outer corners, fold
inner edge, with draw-in roller

Page 61



LÖWE 4.104/Y
Cutter for sealing profiles
at windows and doors
Y-cut, for cutting inner corners

Page 62



LÖWE 4.204
Cutter for sealing profiles
A-Cut

Page 64



LÖWE 3.904/11
Hand eyelet press
self-piercing eyelets
Ø 11 mm

Page 60

LÖWE-Cutters for floor layers



floor layers | tilers | carpenters | window building | electrical installers
 scale modeling | automotive manufacturing | heating and sanitation | leather industry
 sail makers/advertising technicians | painters and upholsterers | drainage technology
 workshop installation | Cutters and spare parts | Promotion materials

OUR ORIGINAL LÖWE ASSORTMENT OF CUTTERS FOR FLOOR LAYERS

Mitre cutters and slat cutters – with or without lever transmission – are indispensable tools for floor layers. They cut three-quarter round slats, threshold profiles, aluminium rails, carpet and facing strips and a wide variety of material types.



LÖWE 3.101 Mitre cutter

for wood, plastic and rubber materials
 without plastic handles, with stop faces at 45°, 50 mm length of cut

21 cm

340 g

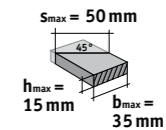

4 033119 000209



LÖWE 3.104 Mitre cutter

for wood, plastic and rubber materials
 with stop faces at 45°, 50 mm length of cut

21 cm

375 g

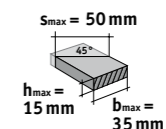

4 033119 000216



LÖWE 3.104/HU Mitre cutter

for hard and flat wood, plastic and rubber materials
with leverage, with stop faces at 45°, 50 mm length of cut

21 cm

390 g



4 033119 000223



LÖWE 3.106 Slat cutter

for wood, plastic and rubber materials
 with stop faces at 90°, 50 mm length of cut

21 cm

370 g

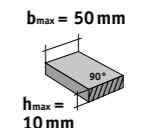

4 033119 000230



LÖWE 3.804 Mitre cutter with trapezoidal blade

for soft wood, plastic and rubber materials
 with trapezoidal blade: quick exchange without disassembly,
 with stop faces at 45°, 50 mm length of cut

21 cm

390 g



4 033119 000452

» WITH THE LÖWE 3.104, MY WORK IS SMOOTHER, MORE
 PRECISE AND MORE EFFICIENTLY THAN WITH A SAW. «

Philipp Geil, Master Parquet Installer, cuts with LÖWE 3.104



All spare parts of the LÖWE Cutters for floor layers can be found from page 48.

LÖWE-Cutters for floor layers



LÖWE 3.306 Slat cutter
for wood, plastic and rubber materials
with stop faces at 90°, 75 mm length of cut

24,5 cm

445 g



b_{max} = 75 mm

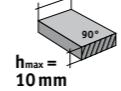

h_{max} = 10 mm



LÖWE 3.306/HU Slat cutter
for hard and flat wood, plastic and rubber materials
with leverage, with stop faces at 90°, 75 mm length of cut

24,5 cm

480 g



b_{max} = 75 mm

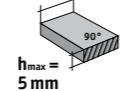

h_{max} = 5 mm



LÖWE 50.130 Lever cutter
for large-format rails and profiles in a wide variety of materials
with stop faces at 45° and 90°

58 cm

3600 g



b_{max} = 130 mm

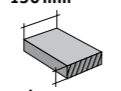

h_{max} = 30 mm



All spare parts of the LÖWE Cutters for floor layers can be found from page 48.

floor layers | tilers | carpenters | window building | electrical installers
scale modeling | automotive manufacturing | heating and sanitation | leather industry
sail makers/advertising technicians | painters and upholsterers | drainage technology
workshop installation | Cutters and spare parts | Promotion materials



1 3.104 MITRE CUTTER

For burr-free and exact cutting of three-quarter round slats on a mitre (45° angle).

2 3.106 SLAT CUTTER

For exact, perpendicular cutting of threshold profiles.

3 3.306 SLAT CUTTER

For burr-free and exact cutting of facing strips at a right angle.

4 3.804 MITRE CUTTER WITH TRAPEZOIDAL BLADE

For burr-free and exact cutting of quarter round slats on a mitre (45° angle).



SCAN TO GET TO THE APPLICATION VIDEOS OF OUR ORIGINAL LÖWE CUTTERS FOR PROFESSIONAL USE

LÖWE-Cutters for tilers



floor layers | **tilers** | carpenters | window building | electrical installers
 scale modeling | automotive manufacturing | heating and sanitation | leather industry
 sail makers/advertising technicians | painters and upholsterers | drainage technology
 workshop installation | Cutters and spare parts | Promotion materials

OUR ORIGINAL LÖWE ASSORTMENT OF CUTTERS FOR TILERS

LÖWE cutters are used by tilers to cut tile profiles on a mitre or to cut aluminium tile profiles, etc. Formation of burrs on the material and messes created from chips are avoided with the use of cutters.



LÖWE 3.101 Mitre cutter

for wood, plastic and rubber materials
 without plastic handles, with stop faces at 45°, 50 mm length of cut

21 cm

340 g

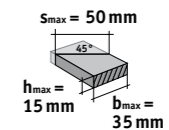

4 033119 000209



LÖWE 3.104 Mitre cutter

for wood, plastic and rubber materials
 with stop faces at 45°, 50 mm length of cut

21 cm

375 g

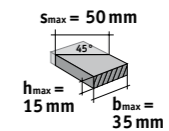

4 033119 000216



LÖWE 3.105 Universal anvil cutter

for wood, plastic and rubber materials
 50 mm length of cut

21 cm

325 g

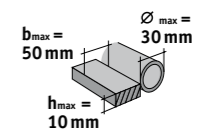

4 033119 000179



LÖWE 3.106 Slat cutter

for wood, plastic and rubber materials
 with stop faces at 90°, 50 mm length of cut

21 cm

370 g

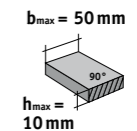

4 033119 000230



LÖWE 3.106/HU Slat cutter

for hard and flat wood, plastic and rubber materials
 with leverage, with stop faces at 90°, 50 mm length of cut

21 cm

410 g

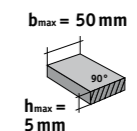

4 033119 000582



» I AM VERY IMPRESSED WITH HOW EASILY I CAN CUT ALUMINIUM TILE PROFILES WITH THE LÖWE 3106/HU FOR SIGNIFICANTLY EASIER WORK WITH OUTSTANDING RESULTS. «

Mike Langfeldt, Master Tiler, cuts with LÖWE 3.106/HU

+ All spare parts of the LÖWE Cutters for tilers can be found from page 48.

LÖWE-Cutters for tilers

floor layers | **tilers** | carpenters | window building | electrical installers
 scale modeling | automotive manufacturing | heating and sanitation | leather industry
 sail makers/advertising technicians | painters and upholsterers | drainage technology
 workshop installation | Cutters and spare parts | Promotion materials



LÖWE 3.804 Mitre cutter with trapezoidal blade

for soft wood, plastic and rubber materials
 with trapezoidal blade: quick exchange without disassembly,
 with stop faces at 45°, 50 mm length of cut

21 cm

390 g

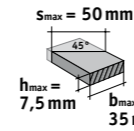

LÖWE 3.805 Universal anvil cutter with trapezoidal blade

for soft wood, plastic and rubber materials
 with trapezoidal blade: quick exchange without disassembly,
 50 mm length of cut

21 cm

350 g

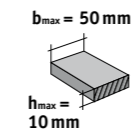

LÖWE 3.806 Flat ribbon cable cutter with trapezoidal blade

for soft wood, plastic and rubber materials
 with trapezoidal blade: quick exchange without disassembly, with stop faces at 90°

21 cm

345 g

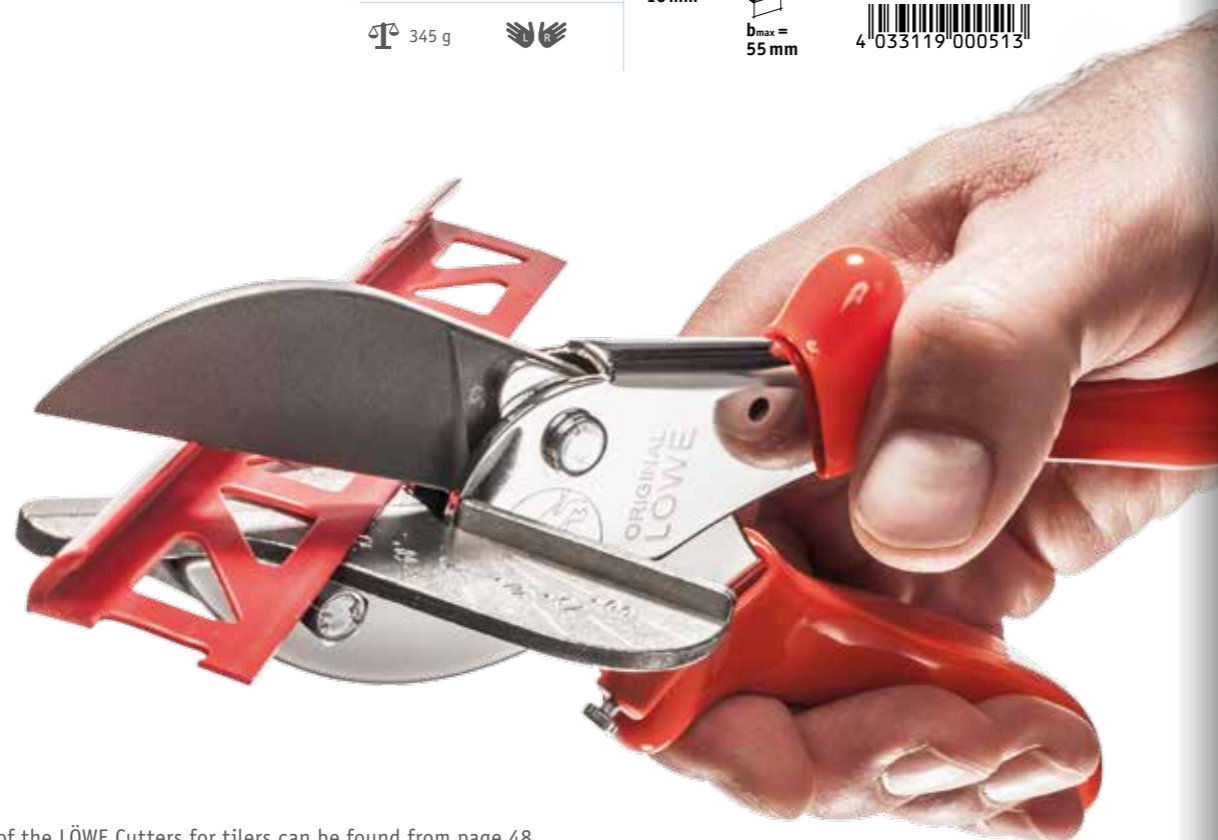
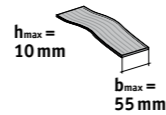

1 3.106/HU SLAT CUTTER

For burr-free and exact cutting of aluminium tile profiles.

2 3.104 MITRE CUTTER

For burr-free and exact cutting of plastic tile profiles.

3 3.804 MITRE CUTTER WITH TRAPEZOIDAL BLADE

For burr-free and exact cutting of plastic tile profiles.



SCAN TO GET TO THE APPLICATION VIDEOS OF OUR ORIGINAL LÖWE CUTTERS FOR PROFESSIONAL USE



All spare parts of the LÖWE Cutters for tilers can be found from page 48.

LÖWE-Cutters for carpenters



floor layers | tilers | **carpenters** | window building | electrical installers
 scale modeling | automotive manufacturing | heating and sanitation | leather industry
 sail makers/advertising technicians | painters and upholsterers | drainage technology
 workshop installation | Cutters and spare parts | Promotion materials

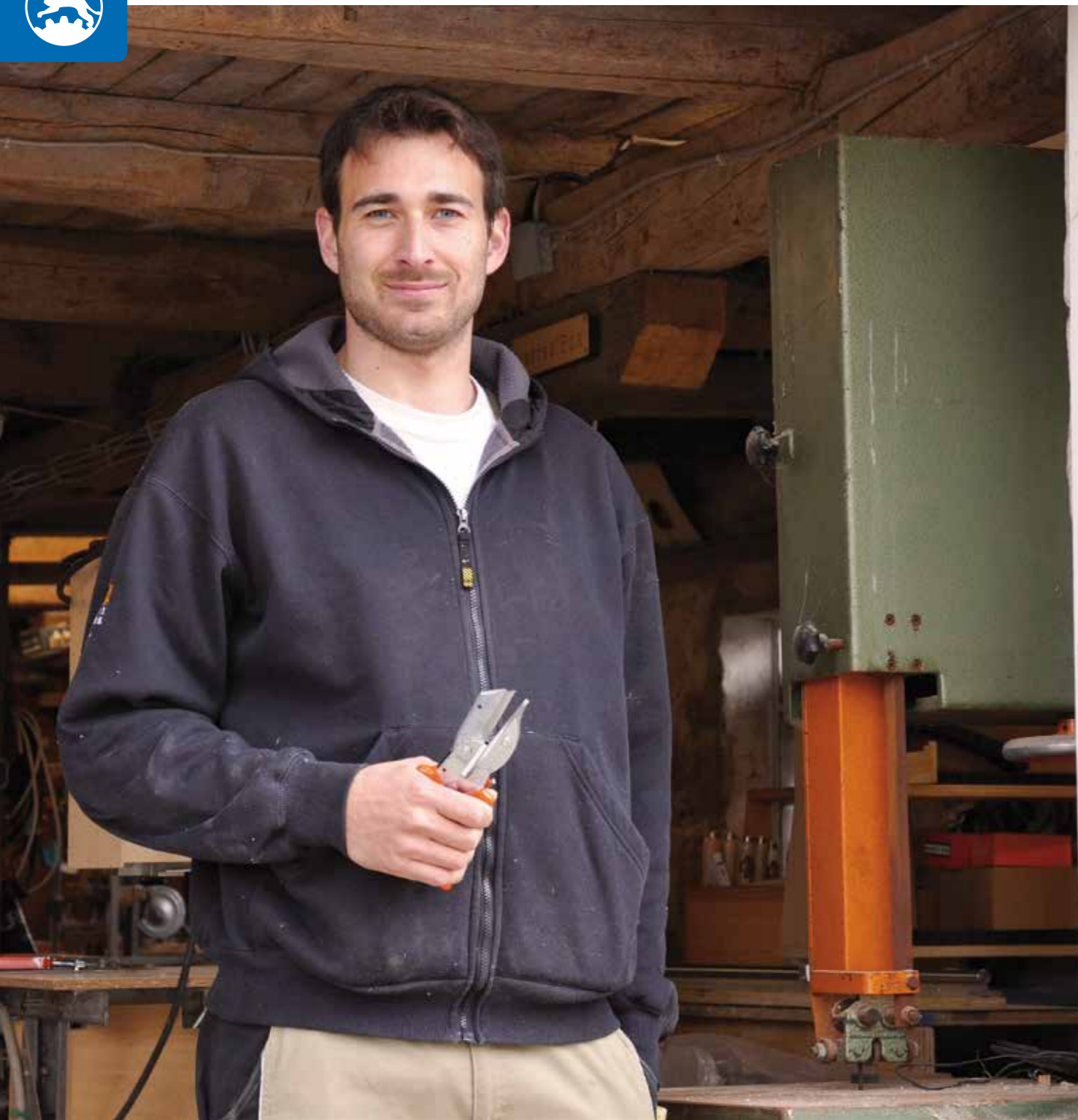

» THIS CUTTER IS SO GOOD, THAT I WOULD ADVERTISE IT! «

Christian Sörensen, Master Carpenter, cuts with LÖWE 3.804

+ All spare parts of the LÖWE Cutters for carpenters can be found from page 48.

OUR ORIGINAL LÖWE ASSORTMENT OF CUTTERS FOR CARPENTERS

LÖWE mitre and slat cutters are the ideal tools for burr-free and exact cutting of plastic and wooden strips, as well as rubber seals. Perfectly cut edges ensure smooth and exact workmanship and the elimination of chips ensures a clean work environment.



LÖWE 3.101 Mitre cutter

for wood, plastic and rubber materials
 without plastic handles, with stop faces at 45°, 50 mm length of cut

21 cm

340 g

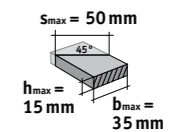

LÖWE 3.104 Mitre cutter

for wood, plastic and rubber materials
 with stop faces at 45°, 50 mm length of cut

21 cm

375 g



LÖWE 3.106 Slat cutter

for wood, plastic and rubber materials
 with stop faces at 90°, 50 mm length of cut

21 cm

370 g

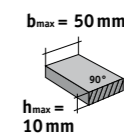

LÖWE 3.106/HU Slat cutter

for hard and flat wood, plastic and rubber materials
with leverage, with stop faces at 90°, 50 mm length of cut

21 cm

410 g

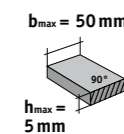

LÖWE 3.106/50K Slat cutter

for wood, plastic and rubber materials
 with stop faces at 90°, with plastic underlayment, 50 mm length of cut

21 cm

315 g

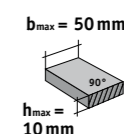

LÖWE-Cutters for carpenters



LÖWE 3.306/HU Slat cutter

for hard and flat wood, plastic and rubber materials
with leverage, with stop faces at 90°, 75 mm length of cut

24,5 cm

480 g



b_{max} = 75 mm

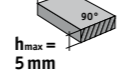

h_{max} = 5 mm



4 033119 000278



LÖWE 3.804 Mitre cutter with trapezoidal blade

for soft wood, plastic and rubber materials
with trapezoidal blade: quick exchange without disassembly,
with stop faces at 45°, 50 mm length of cut

21 cm

390 g



s_{max} = 50 mm

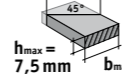

h_{max} = 7,5 mm

b_{max} = 35 mm



4 033119 000452



SCAN TO GET TO THE
APPLICATION VIDEOS OF OUR
ORIGINAL LÖWE CUTTERS FOR
PROFESSIONAL USE



1 3.104 MITRE CUTTER

For burr-free and exact cutting of wooden moulding on a mitre.

2 3.106/50K SLAT CUTTER

For burr-free and easy tailoring of individual dowels.

3 3.804 MITRE CUTTER WITH TRAPEZOIDAL BLADE

For burr-free and exact cutting of soft and thin wooden strips and wooden edging.

4 3.101 MITRE CUTTER

For burr-free and exact cutting of three-quarter round slats.

5 3.106 SLAT CUTTER

For burr-free and exact cutting of hollow slats.



All spare parts of the LÖWE Cutters for carpenters can be found from page 48.

floor layers | tilers | **carpenters** | window building | electrical installers
scale modeling | automotive manufacturing | heating and sanitation | leather industry
sail makers/advertising technicians | painters and upholsterers | drainage technology
workshop installation | Cutters and spare parts | Promotion materials



LÖWE-Cutters for window building



floor layers | tilers | carpenters | **window building** | electrical installers
 scale modeling | automotive manufacturing | heating and sanitation | leather industry
 sail makers/advertising technicians | painters and upholsterers | drainage technology
 workshop installation | Cutters and spare parts | Promotion materials



» THE BEST RESULTS CAN ONLY BE ACHIEVED WITH THE BEST TOOLS, WHICH IS WHY I HAVE SWORN BY ORIGINAL LÖWE CUTTERS FOR YEARS. «

Olaf Jöster, Master Carpenter, cuts with LÖWE 4.104/VR

✦ All spare parts of the LÖWE Cutters for window building can be found from page 48.

OUR ORIGINAL LÖWE ASSORTMENT OF CUTTERS FOR WINDOW BUILDING

Original LÖWE cutters are indispensable tools in window building for burr-free and exact cutting of plastic moulding, seal strips, wooden moulding and for tailoring of seal profiles.



LÖWE 3.101 Mitre cutter

for wood, plastic and rubber materials
 without plastic handles, with stop faces at 45°, 50 mm length of cut

21 cm

340 g

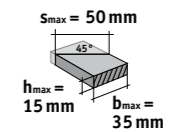

LÖWE 3.104 Mitre cutter

for wood, plastic and rubber materials
 with stop faces at 45°, 50 mm length of cut

21 cm

375 g

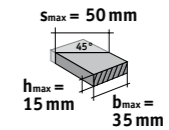

LÖWE 3.106 Slat cutter

for wood, plastic and rubber materials
 with stop faces at 90°, 50 mm length of cut

21 cm

370 g

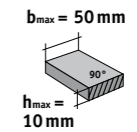

LÖWE 3.106/50K Slat cutter

for wood, plastic and rubber materials
 with stop faces at 90°, with plastic underlayment, 50 mm length of cut

21 cm

315 g

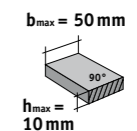

LÖWE 3.804 Mitre cutter with trapezoidal blade

for soft wood, plastic and rubber materials
 with trapezoidal blade: quick exchange without disassembly,
 with stop faces at 45°, 50 mm length of cut

21 cm

390 g



✦ Also available for window building: LÖWE 3.806 Flat ribbon cable cutter with trapezoidal blade for soft wood, plastic and rubber materials (page 59).

LÖWE-Cutters for window building

floor layers | tilers | carpenters | **window building** | electrical installers
 scale modeling | automotive manufacturing | heating and sanitation | leather industry
 sail makers/advertising technicians | painters and upholsterers | drainage technology
 workshop installation | Cutters and spare parts | Promotion materials



LÖWE 4.104/V Cutter for sealing profiles

for window seals
 V-cut, for cutting outer corners, fold inner edge



LÖWE 4.104/VR Cutter for sealing profiles

for window seals
 V-cut, for cutting outer corners, fold inner edge,
 with draw-in roller



LÖWE 4.104/Y Cutter for sealing profiles

for window seals
 Y-cut, for cutting inner corners



LÖWE 4.104/YR Cutter for sealing profiles

for window seals
 Y-cut, for cutting inner corners, with draw-in roller



LÖWE 4.204 Cutter for sealing profiles

for expansion beads of facade sealing band
 A-cut, reverse arrangement of the blades compared to model 4.104



INSTRUCTIONS FOR CUTTERS FOR SEALING PROFILES:

Use V-Cut | outer corner

Use Y-Cut | inner corner



1. Fix window seal and let it run down across window-frame 2. Apply cutter flush with first stop angle to window-frame, then position window seal straight on base 3. The result of the following cut is a notch in the window seal 4. Now it's possible to fix the window seal at right angles easily 5. For the final cut apply cutter with second stop angle at window seal 6. The beginning and end of the window seal meet flush

1. Fix window seal and let it run down across window-frame 2. Apply cutter flush with stop plate to window-frame, then position window seal straight on base 3. The result of the following cut is a notch in the window seal 4. With the gained rear tension release of the seal, it's possible to fix the window seal at right angles easily 5. Now the window seal can be fitted easily into the corner 6. The result is an efficient and uninterrupted inner corner of the window seal

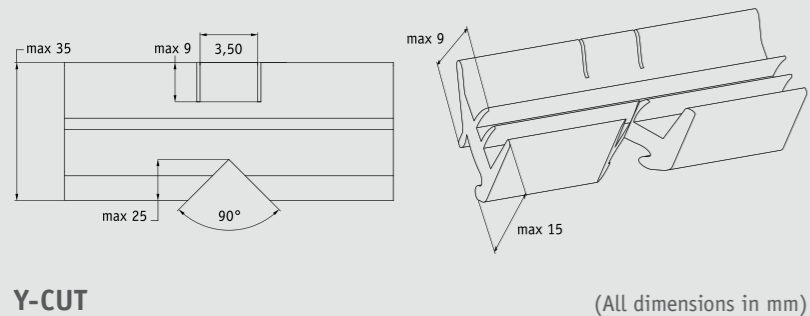

(All dimensions in mm)

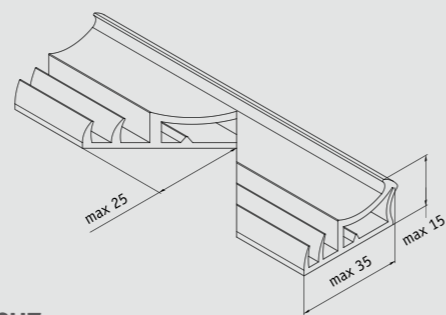

LÖWE-Cutters for window building

floor layers | tilers | carpenters | **window building** | electrical installers
 scale modeling | automotive manufacturing | heating and sanitation | leather industry
 sail makers/advertising technicians | painters and upholsterers | drainage technology
 workshop installation | Cutters and spare parts | Promotion materials



1



2



3



4



5



6

1 3.106 SLAT CUTTER

For burr-free and exact cutting of plastic moulding at a right angle.

2 3.806 FLAT RIBBON CABLE CUTTER WITH TRAPEZOIDAL BLADE

For burr-free and exact cutting of hollow cover strips at a right angle.

3 3.804 MITRE CUTTER WITH TRAPEZOIDAL BLADE

For burr-free and exact cutting of wooden moulding on a mitre.

4 3.106/50K SLAT CUTTER

For burr-free and exact cutting of sealing strip at a right angle.

5 6 3.101 MITRE CUTTER

For burr-free and exact cutting of quarter round slats on a mitre.



All spare parts of the LÖWE Cutters for window building can be found from page 48.

LÖWE-Cutters for electrical installers



floor layers | tilers | carpenters | window building | **electrical installers**
 scale modeling | automotive manufacturing | heating and sanitation | leather industry
 sail makers/advertising technicians | painters and upholsterers | drainage technology
 workshop installation | Cutters and spare parts | Promotion materials



OUR ORIGINAL LÖWE ASSORTMENT OF CUTTERS FOR ELECTRICAL INSTALLERS

Original LÖWE cutters enable burr-free and exact cutting of cable conduit and plastic rails for electrical installation. The cutters are available with faces for 45° or 90° or without faces. The model with lever transmission is especially well-suited for cutting flat and particularly hard materials.



LÖWE 3.204/16U19 Tube cutter

for PVC pipes

21,5 cm

360 g

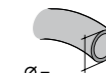

Ø =
16 mm und 19 mm
other diameters
available on request



4 033119 000346



LÖWE 3.204/P90 Tube and hose cutter

for PVC pipes and hoses

21,5 cm

370 g

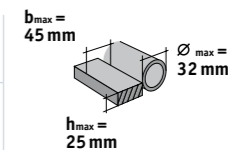

4 033119 000391



LÖWE 3.604 Cable duct cutter

for PVC cable and wiring conduit and plastic rails
with stop faces at 45°

24,5 cm

400 g

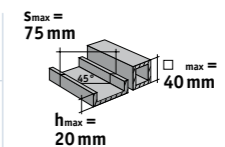

4 033119 000285



LÖWE 3.606 Cable duct cutter

for PVC cable and wiring conduit and plastic rails
with stop faces at 90°

24,5 cm

390 g

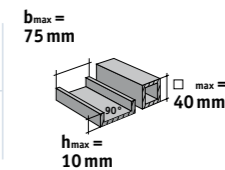

4 033119 000520



LÖWE 3.606/HU Cable duct cutter

for hard and flat PVC cable and wiring conduit and plastic rails
with leverage, with stop faces at 90°

24,5 cm

425 g

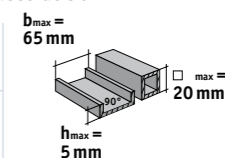

4 033119 000544

» I CAN WORK MUCH MORE FLEXIBLY AND EFFECTIVELY WITH LÖWE CABLE CONDUIT CUTTERS. IT MAKES AN INCREDIBLE DIFFERENCE. «

Johannes Rohwer, Mechatronic Technician, cuts with LÖWE 3.606



All spare parts of the LÖWE Cutters for electrical installers can be found from page 48.

LÖWE-Cutters for electrical installers



LÖWE 3.704/16U19 Tube cutter for cable conduits

23 cm

315 g

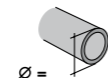

Ø =
16 mm und 19 mm
Andere Ø auf Anfrage
erhältlich.



4 033119 000421



LÖWE 5.104/P90 Tube and hose cutter for PVC pipes and hoses small version

17,5 cm

200 g

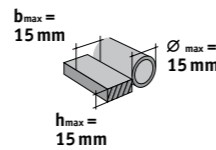

$b_{max} = 15\text{ mm}$
 $h_{max} = 15\text{ mm}$
 $\varnothing_{max} = 15\text{ mm}$



4 033119 000407



LÖWE 5.504 Hose cutter for corrugated pipe and soft hoses with triangular blade

23 cm

270 g



$\varnothing_{max} = 28\text{ mm}$



4 033119 000773



LÖWE 51.130 Lever cutters for large-format PVC wire conduit and hard and flat plastic rails, with stop faces at 90°

58 cm

3800 g

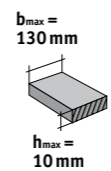

$b_{max} = 130\text{ mm}$
 $h_{max} = 10\text{ mm}$



4 033119 000797



SCAN TO GET TO THE
APPLICATION VIDEOS OF OUR
ORIGINAL LÖWE CUTTERS FOR
PROFESSIONAL USE

floor layers | tilers | carpenters | window building | **electrical installers**
scale modeling | automotive manufacturing | heating and sanitation | leather industry
sail makers/advertising technicians | painters and upholsterers | drainage technology
workshop installation | Cutters and spare parts | Promotion materials



1



2



3

1 3.606 CABLE DUCT CUTTER

For burr-free and easy cutting wire and cable conduit at a 90° angle.

2 3.606/HU CABLE DUCT CUTTER

For burr-free and easy cutting of wire and cable conduit at a 90° angle with lever transmission especially well-suited for thicker and harder conduit.

3 5.504 HOSE CUTTER

For exact and perpendicular cutting of corrugated pipe at the crest or trough of the corrugation.

+ All spare parts of the LÖWE Cutters for electrical installers can be found from page 48.

LÖWE-Cutters for scale modeling

floor layers | tilers | carpenters | window building | electrical installers
 scale modeling | automotive manufacturing | heating and sanitation | leather industry
 sail makers/advertising technicians | painters and upholsterers | drainage technology
 workshop installation | Cutters and spare parts | Promotion materials



1 2 3.805 ANVIL CUTTER WITH TRAPEZOIDAL BLADE

For burr-free and exact cutting of soft materials, such as plastic rods, wooden rods or balsa wood.

3 3.101 MITRE CUTTER

For burr-free and exact cutting of wooden strips on a mitre.

» WORKING WITH DELICATE MATERIALS IS A CENTRAL ELEMENT OF DAILY WORK IN SCALE MODELING. THE DESIRED RESULTS CAN ONLY BE ACHIEVED WITH ABSOLUTELY PRECISE TOOLS, WHICH IS WHY MY LÖWE CUTTER IS ONE OF MY STANDARD TOOLS. «

Pia Jahn, Model Builder, cuts with LÖWE 3.805

+ All spare parts of the LÖWE Cutters for scale modeling can be found from page 48.

OUR ORIGINAL LÖWE ASSORTMENT OF CUTTERS FOR SCALE MODELING

Exact and burr-free cutting are mandatory for perfect results in scale modeling. Original LÖWE cutters are the ideal tools for a wide range of applications, including very soft materials. LÖWE cutters have been a standard tool for nativity building for decades.



LÖWE 3.101 Mitre cutter

for wood, plastic and rubber materials
 without plastic handles, with stop faces at 45°, 50 mm length of cut

21 cm

340 g

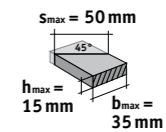

4 033119 000209



LÖWE 3.104 Mitre cutter

for wood, plastic and rubber materials
 with stop faces at 45°, 50 mm length of cut

21 cm

375 g



4 033119 000216



LÖWE 3.105 Universal anvil cutter

for wood, plastic and rubber materials
 50 mm length of cut

21 cm

325 g

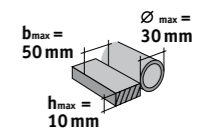

4 033119 000179



LÖWE 3.804 Mitre cutter with trapezoidal blade

for soft wood, plastic and rubber materials
 with trapezoidal blade: quick exchange without disassembly,
 with stop faces at 45°, 50 mm length of cut

21 cm

390 g

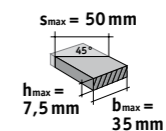

4 033119 000452



LÖWE 3.805 Universal anvil cutter with trapezoidal blade

for soft wood, plastic and rubber materials
 with trapezoidal blade: quick exchange without disassembly,
 50 mm length of cut

21 cm

350 g

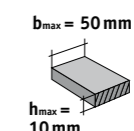

4 033119 000735

LÖWE-Cutters for automotive manufacturing

floor layers | tilers | carpenters | window building | electrical installers
 scale modeling | **automotive manufacturing** | heating and sanitation | leather industry
 sail makers/advertising technicians | painters and upholsterers | drainage technology
 workshop installation | Cutters and spare parts | Promotion materials



» THE LÖWE 5.504 IS POSITIONED ON TOP OF THE HOSE AND THEN CUTS IT FROM THE INSIDE OUT. THE CUT IS INCREDIBLY PRECISE ON SOFT HOSES. «

Volker Krüger, Automotive Mechatronic Technician, cuts with LÖWE 5.504

1 3.204/P90 TUBE AND HOSE CUTTER

For burr-free and exact cutting of plastic lines at a right angle.

2 5.104/P90 TUBE AND HOSE CUTTER

For burr-free and exact cutting of harder corrugated tubes at a right angle.

3 For burr-free and exact cutting of fuel hoses at a right angle.

4 5.504 HOSE CUTTER

For burr-free and exact cutting of softer corrugated tubes with a diameter of up to 28 mm at a right angle.

OUR ORIGINAL LÖWE ASSORTMENT OF CUTTERS FOR AUTOMOTIVE MANUFACTURING

The requirements for exact cutting of tubes and hoses are extremely high in the automotive industry, in particular. Original LÖWE cutters enable burr-free and absolutely precise cutting of tubes, corrugated tubes, soft hoses and fuel lines.



LÖWE 1.105 Universal anvil cutter

for all materials (except for metal)
 40 mm length of cut

20 cm	$b_{max} = 40\text{ mm}$ $h_{max} = 7,5\text{ mm}$ $\varnothing_{max} = 25\text{ mm}$	
295 g		4 033119 000049



LÖWE 5.104/P90 Tube and hose cutter

for PVC pipes and hoses
 small version

17,5 cm	$b_{max} = 15\text{ mm}$ $h_{max} = 15\text{ mm}$ $\varnothing_{max} = 15\text{ mm}$	
200 g		4 033119 000047



LÖWE 3.204/P90 Tube and hose cutter

for PVC pipes and hoses

21,5 cm	$b_{max} = 45\text{ mm}$ $h_{max} = 25\text{ mm}$ $\varnothing_{max} = 32\text{ mm}$	
370 g		4 033119 000039



LÖWE 3.806 Flat ribbon cable cutter with trapezoidal blade

for soft wood, plastic and rubber materials
 with trapezoidal blade: quick exchange without disassembly, stop faces at 90°

21 cm	$h_{max} = 10\text{ mm}$ $b_{max} = 55\text{ mm}$	
345 g		4 033119 000513



LÖWE 5.504 Hose cutter

for corrugated pipe and soft hoses
 with triangular blade

23 cm	$\varnothing_{max} = 28\text{ mm}$	
270 g		4 033119 000773



All spare parts of the LÖWE Cutters for automotive manufacturing can be found from page 48.

LÖWE-Cutters for heating and sanitation

floor layers | tilers | carpenters | window building | electrical installers
 scale modeling | automotive manufacturing | **heating and sanitation** | leather industry
 sail makers/advertising technicians | painters and upholsterers | drainage technology
 workshop installation | Cutters and spare parts | Promotion materials



3.204/P90 TUBE AND HOSE CUTTER

For burr-free and exact cutting of aluminium composite pipes:

- 1 24 mm diameter
- 2 16 mm diameter
- 3 For burr-free and exact cutting of plastic lines for underfloor heating.

» THE LÖWE 3204/P90 HOSE CUTTER CUTS EASILY AND PRECISELY THROUGH ALUMINIUM COMPOSITE PIPES, WHERE OTHER TUBE CUTTERS ARE COMPLETELY USELESS. «

Michael Biermann, Gas and Water Installer, cuts with LÖWE 3.204/P90

All spare parts of the LÖWE Cutters for heating and sanitation can be found from page 48.

OUR ORIGINAL LÖWE ASSORTMENT OF CUTTERS FOR HEATING AND SANITATION

Original LÖWE tube and hose cutters are ideal for speedy and impressive cutting of plastic pipes and aluminium composite pipes. Burrs and chips are a thing of the past and the user is significantly more mobile and is no longer bound to a fixed work station for the preparation of materials.



LÖWE 3.204/P90 Tube and hose cutter

for PVC pipes and hoses

21,5 cm	370 g			
---------	-------	--	--	--



LÖWE 5.104/P90 Tube and hose cutter

for PVC pipes and hoses small version

17,5 cm	200 g			
---------	-------	--	--	--



LÖWE 5.504 Hose cutter

for corrugated pipe and soft hoses with triangular blade

23 cm	270 g			
-------	-------	--	--	--



SCAN TO GET TO THE APPLICATION VIDEOS OF OUR ORIGINAL LÖWE CUTTERS FOR PROFESSIONAL USE



LÖWE-Cutters for the leather industry

floor layers | tilers | carpenters | window building | electrical installers
 scale modeling | automotive manufacturing | heating and sanitation | **leather industry**
 sail makers/advertising technicians | painters and upholsterers | drainage technology
 workshop installation | Cutters and spare parts | Promotion materials



1 2 3.806 FLAT RIBBON CABLE CUTTER WITH TRAPEZOIDAL BLADE

For fibre-free and exact cutting of leather belts and straps.

3 3.805 ANVIL CUTTER WITH TRAPEZOIDAL BLADE

For fibre-free and exact cutting of soft leather.

4 1.105 ANVIL CUTTER

For fibre-free and exact contouring of soft leather.

» I USE ORIGINAL LÖWE CUTTERS EVERY DAY FOR LEATHER WORKING. THEY CUT HIGH-QUALITY AND EVEN FIBROUS MATERIALS PRECISELY AND ACCURATELY. «

Stephanie Koop, Stoffkontor Kiel, cuts with LÖWE 1.105

+ All spare parts of the LÖWE Cutters for the leather industrie can be found from page 48.

OUR ORIGINAL LÖWE ASSORTMENT OF CUTTERS FOR THE LEATHER INDUSTRY

Original LÖWE cutters are the perfect tools for working with soft or hard leather.



LÖWE 1.105 Universal anvil cutter

for all materials (except for metal)
 40 mm length of cut

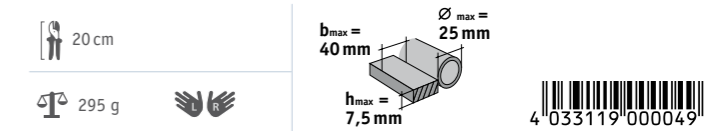

LÖWE 3.804 Mitre cutter with trapezoidal blade

for soft wood, plastic and rubber materials and leather
 with trapezoidal blade: quick exchange without disassembly,
 with stop faces at 45°, 50 mm length of cut

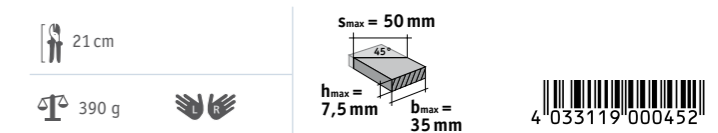

LÖWE 3.805 Universal anvil cutter with trapezoidal blade

for soft wood, plastic and rubber materials
 with trapezoidal blade: quick exchange without disassembly,
 50 mm length of cut

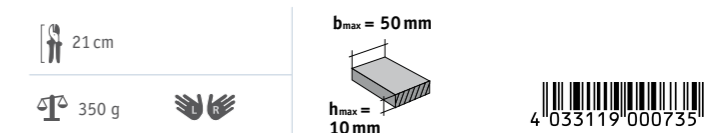

LÖWE 3.806 Flat ribbon cable cutter with trapezoidal blade

for soft wood, plastic and rubber materials and leather
 with trapezoidal blade: quick exchange without disassembly, stop faces at 90°

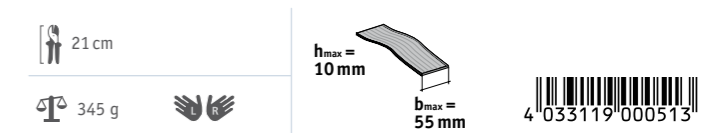

SCAN TO GET TO THE APPLICATION VIDEOS OF OUR ORIGINAL LÖWE CUTTERS FOR PROFESSIONAL USE



Cutters for sail makers/advertising technicians

floor layers | tilers | carpenters | window building | electrical installers
 scale modeling | automotive manufacturing | heating and sanitation | leather industry
sail makers/advertising technicians | painters and upholsterers | drainage technology
 workshop installation | Cutters and spare parts | Promotion materials



OUR ORIGINAL LÖWE ASSORTMENT OF CUTTERS FOR SAIL MAKERS/ADVERTISING TECHNICIANS

For exact positioning and cutting of eyes for sails and advertising banners, the user requires an absolutely reliable tool: a hand eyelet press from Original LÖWE.



LÖWE 3.904/9.5 Hand eyelet press

for tarpaulins, banners and sails
 suited for self-piercing eyelets in foil and tarpaulins

20 cm

Ø = 9,5 mm

435 g

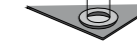

LÖWE 3.904/11 Hand eyelet press

for tarpaulins, banners and sails
 suited for self-piercing eyelets in foil and tarpaulins

20 cm

Ø = 11 mm

470 g



SCAN TO GET TO THE APPLICATION VIDEOS OF OUR ORIGINAL LÖWE CUTTERS FOR PROFESSIONAL USE

» THE HAND EYELET PRESS MAKES ME EXTREMELY FLEXIBLE, BECAUSE I DON'T HAVE TO REMAIN IN A PERMANENT LOCATION. THE EYES CUT INTO THE MATERIAL PERFECTLY. «

Tobias Lemke, Sail Maker, works with LÖWE 3.904/9.5



All spare parts of the LÖWE Cutters for sail makers/advertising technicians can be found from page 48.

LÖWE-Cutters for painters and upholsterers



1 3.804 MITRE CUTTER WITH TRAPEZOIDAL BLADE

For burr-free and exact cutting of base-board/three-quarter round slats.

2 3.106 SLAT CUTTER

For burr-free and exact cutting of crown moulding.

3 4 3.806 FLAT RIBBON CABLE CUTTER WITH TRAPEZOIDAL BLADE

For burr-free and exact cutting of ceiling moulding.

5 3.106 SLAT CUTTER

For burr-free and exact cutting of ceiling moulding.

» LÖWE CUTTERS CUT CEILING MOULDING, BASEBOARD AND CROWN MOULDING EASILY AND PRECISELY FOR PREPARATION ACCORDING TO INDIVIDUAL REQUIREMENTS – SIMPLY PERFECT! «

Marcel Münch, Painter, cuts with LÖWE 3.104



SCAN TO GET TO THE APPLICATION VIDEOS OF OUR ORIGINAL LÖWE CUTTERS FOR PROFESSIONAL USE

All spare parts of the LÖWE Cutters for painters and upholsterers can be found from page 48.

OUR ORIGINAL LÖWE ASSORTMENT OF CUTTERS FOR PAINTERS AND UPHOLSTERERS

Original LÖWE cutters cut ceiling mouldings, baseboard and crown mouldings easily and precisely for preparation according to individual requirements. A precise mitre cut, perpendicular cut or individual application is guaranteed with the different faces.



LÖWE 3.101 Mitre cutter

for wood, plastic and rubber materials
 without plastic handles, with stop faces at 45°, 50 mm length of cut

21 cm

340 g

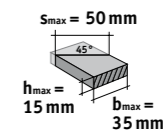

LÖWE 3.104 Mitre cutter

for wood, plastic and rubber materials
 with stop faces at 45°, 50 mm length of cut

21 cm

375 g

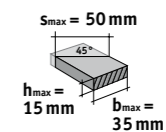

LÖWE 3.106 Slat cutter

for wood, plastic and rubber materials
 with stop faces at 90°, 50 mm length of cut

21 cm

370 g

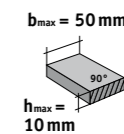

LÖWE 3.804 Mitre cutter with trapezoidal blade

for soft wood, plastic and rubber materials
 with trapezoidal blade: quick exchange without disassembly,
 with stop faces at 45°, 50 mm length of cut

21 cm

390 g

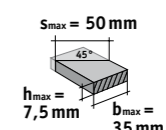

LÖWE 3.806 Flat ribbon cable cutter with trapezoidal blade

for soft wood, plastic and rubber materials
 with trapezoidal blade: quick exchange without disassembly, stop faces at 90°

21 cm

345 g

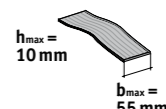

LÖWE-Cutters for drainage technology

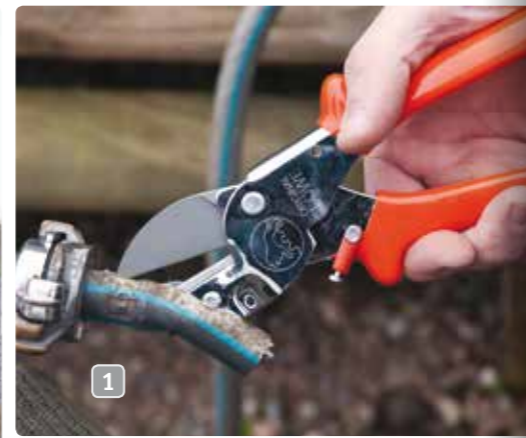

1 1.105 ANVIL CUTTER

For longitudinal cutting of hoses in order to make the connection accessible again.

3.204/P90 TUBE AND HOSE CUTTER

2 To cleanly cut thick-walled and hard hoses to length.

3 For burr-free cutting of PVC drainage pipes at a 90° angle.

5.504 HOSE CUTTER

4 For exact and perpendicular cutting of corrugated pipe at the crest or trough of the corrugation.

5 For exact, perpendicular cutting of water hoses.

» WE HAVE WORKED EXCLUSIVELY WITH LÖWE CUTTERS FOR CLEAN AND PERFECT INSTALLATION IN DRAINAGE SYSTEMS FOR YEARS. «

Fridolin Klemm, Horticulturist and Garden Centre Owner, cuts with LÖWE 3.204/P90

OUR ORIGINAL LÖWE ASSORTMENT OF CUTTERS FOR DRAINAGE TECHNOLOGY

An absolutely exact and perpendicular cut of hoses and pipes is often essential in drainage technology, because it is the only way to ensure proper connection. This is precisely what Original LÖWE tube and hose cutters offer.



LÖWE 1.105 Universal anvil cutter

for all materials (except for metal)
 40 mm length of cut

20 cm

295 g

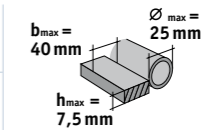

LÖWE 3.204/P90 Tube and hose cutter

for PVC pipes and hoses

21,5 cm

370 g

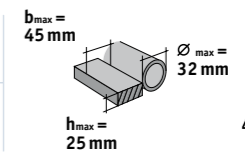

LÖWE 5.104/P90 Tube and hose cutter

for PVC pipes and hoses
 small version

17,5 cm

200 g

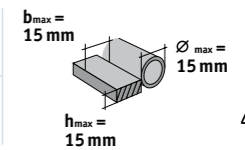

LÖWE 5.504 Hose cutter

for corrugated pipe and soft hoses
 with triangular blade

23 cm

270 g

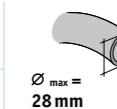

SCAN TO GET TO THE APPLICATION VIDEOS OF OUR ORIGINAL LÖWE CUTTERS FOR PROFESSIONAL USE



All spare parts of the LÖWE Cutters for for drainage technology can be found from page 48.

LÖWE-Cutters for workshop installation

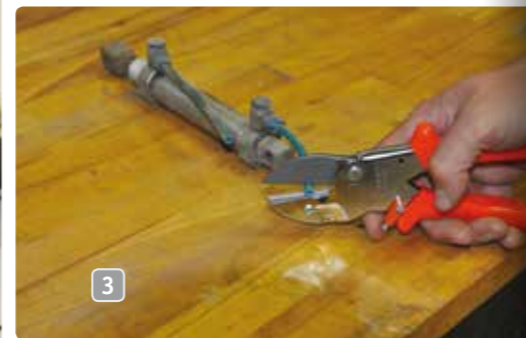

3.104 MITRE CUTTER

- 1 For exact cutting of seals on a mitre.
- 2 For burr-free and exact cutting of HDF-board on a mitre.

1.105 ANVIL CUTTER

- 3 For exact cutting of rubber hoses.
- 4 For exact cutting of ropes and belts.

» I EXPECT EXACT RESULTS WITH MY WORK. THEREFORE, GOOD TOOLS ARE A NECESSITY. I CAN CUT ALMOST ANYTHING EXCEPT FOR METAL WITH MY LÖWE CUTTERS. NO WORKSHOP SHOULD BE WITHOUT LÖWE CUTTERS. «

Matthias Huge, Machine Builder and Professional Craftsman, cuts with LÖWE 3.104

OUR ORIGINAL LÖWE ASSORTMENT OF CUTTERS FOR WORKSHOP INSTALLATION

Original LÖWE cutters are an indispensable tool that no workshop should be without for versatile use on materials such as wood, PVC, rubber, leather, etc.



LÖWE 1.105 Universal anvil cutter

for all materials (except for metal)
40 mm length of cut

20 cm

295 g

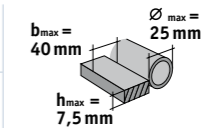

LÖWE 3.101 Mitre cutter

for wood, plastic and rubber materials
without plastic handles, with stop faces at 45°, 50 mm length of cut

21 cm

340 g

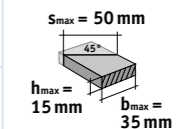

LÖWE 3.104 Mitre cutter

for wood, plastic and rubber materials
with stop faces at 45°, 50 mm length of cut

21 cm

375 g

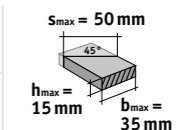

LÖWE 5.105 small anvil cutter

for all materials (except for metal)
25 mm length of cut

17,5 cm

190 g

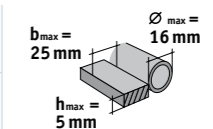

SCAN TO GET TO THE APPLICATION VIDEOS OF OUR ORIGINAL LÖWE CUTTERS FOR PROFESSIONAL USE



All spare parts of the LÖWE Cutters for workshop installation can be found from page 48.

Cutters and Spare parts

floor layers | tilers | carpenters | window building | electrical installers
 scale modeling | automotive manufacturing | heating and sanitation | leather industry
 sail makers/advertising technicians | painters and upholsterers | drainage technology
 workshop installation | **Cutters and spare parts** | Promotion materials



LÖWE 1.105 Universal anvil cutter

for all materials (except for metal)
 40 mm length of cut

20 cm

295 g

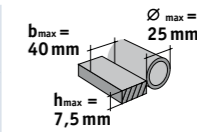

4 033119 000049

Spare parts			Item No.	Description	EAN-Code
			1001	Blade LÖWE 1, 5 pieces in a box	4 033119 001015
			1001/B	Blade LÖWE 1, 1 piece in a blister	4 033119 001183
			1002	Anvil (base) LÖWE 1/2	4 033119 001503
			1002/B	Anvil (base) for LÖWE 1/2 with screw and sleeve, including: 1002 + 1006	4 033119 001794
			1003	Spring with screw and nut	4 033119 002012
			1004/04	Pair of handles for handle type 04	4 033119 002029
			1005	Bolt with sleeve and nut	4 033119 002036
			1006	Screws with sleeve for anvil	4 033119 002043
			1007	Set spare parts LÖWE 1 in a blister, including: 1001/B + 1002 + 1003 + 1005 + 1006	4 033119 002517
			1009	Fastener	4 033119 002197

INDEX

LÖWE 1.105	Page 49	LÖWE 3.904/9.5, 3.904/11	Page 60
LÖWE 3.101, 3.104, 3.105, 3.106, 3.106/50K	Page 50	LÖWE 4.104/V, 4.104/VR	Page 61
LÖWE 3.104/HU, 3.105/HU, 3.106/HU	Page 52	LÖWE 4.104/Y, 4.104/YR	Page 62
LÖWE 3.204, 3.204/16U19, 3.204/P90	Page 53	Instructions for Cutters for sealing profiles	Page 63
LÖWE 3.304, 3.305, 3.306	Page 54	LÖWE 4.204	Page 64
LÖWE 3.304/HU, 3.305/HU, 3.306/HU	Page 55	LÖWE 5.104/P90	Page 65
LÖWE 3.604, 3.605, 3.606	Page 56	LÖWE 5.105, 5.504	Page 66
LÖWE 3.604/HU, 3.605/HU, 3.606/HU	Page 57	LÖWE 50.130, 51.130	Page 67
LÖWE 3.704, 3.704/16U19	Page 58	Accessories and Promotion materials	Page 67
LÖWE 3.804, 3.805, 3.806	Page 59		



SCAN TO GET TO THE APPLICATION VIDEOS OF OUR ORIGINAL LÖWE CUTTERS FOR PROFESSIONAL USE

Cutters and Spare parts



LÖWE 3.101 Mitre cutter

for wood, plastic and rubber materials
without plastic handles, with stop faces at 45°, 50 mm length of cut

21 cm

340 g

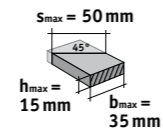

LÖWE 3.104 Mitre cutter

for wood, plastic and rubber materials
with stop faces at 45°, 50 mm length of cut

21 cm

375 g

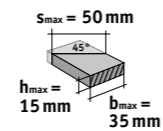

LÖWE 3.105 Universal anvil cutter

for wood, plastic and rubber materials
50 mm length of cut

21 cm

325 g

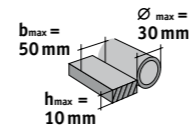

LÖWE 3.106 Slat cutter

for wood, plastic and rubber materials
with stop faces at 90°, 50 mm length of cut

21 cm

370 g

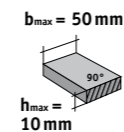

LÖWE 3.106/50K Slat cutter

for wood, plastic and rubber materials
with stop faces at 90°, with plastic underlayment, 50 mm length of cut

21 cm

315 g

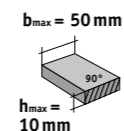

floor layers | tilers | carpenters | window building | electrical installers
scale modeling | automotive manufacturing | heating and sanitation | leather industry
sail makers/advertising technicians | painters and upholsterers | drainage technology
workshop installation | **Cutters and spare parts** | Promotion materials



Spare parts			Item No.	Description	EAN-Code
			3001/B	Blade LÖWE 3, 1 piece in a blister	4 033119 001206
			3001	Blade LÖWE 3, 5 pieces in a box	4 033119 001091
			3002	Anvil (base) for mitre cutter, 50 mm length of cut	4 033119 001565
			3002/OG50	Anvil (base) for 50 mm length of cut	4 033119 001824
			3002/50K	Anvil (base) for flat ribbon cable cutter, 50 mm length of cut	4 033119 001800
			3002/3106	Pair of stop faces 90° for slat cutter	4 033119 002463
			1003	Spring with screw and nut	4 033119 002012
			1004/04	Pair of handles for handle type 04	4 033119 002029
			1005	Bolt with sleeve and nut	4 033119 002036
			3006	Screw with nut for anvil (base)	4 033119 002302
			3007	Set spare parts LÖWE 3 in a blister, including: 3001/B + 3002 + 1005 + 3006	4 033119 002609
			1009	Fastener	4 033119 002197



SCAN TO GET TO THE
APPLICATION VIDEOS OF OUR
ORIGINAL LÖWE CUTTERS FOR
PROFESSIONAL USE

Cutters and Spare parts



LÖWE 3.104/HU Mitre cutter

for hard and flat wood, plastic and rubber materials
with leverage, with stop faces at 45°, 50 mm length of cut

21 cm
390 g

$s_{max} = 50\text{ mm}$
 $h_{max} = 5\text{ mm}$
 $b_{max} = 35\text{ mm}$

4 033119 000223



LÖWE 3.105/HU Anvil cutter

for hard and flat wood, plastic and rubber materials
with leverage, 50 mm length of cut

21 cm
350 g

$b_{max} = 50\text{ mm}$
 $h_{max} = 5\text{ mm}$

4 033119 000575



LÖWE 3.106/HU Slat cutter

for hard and flat wood, plastic and rubber materials
with leverage, with stop faces at 90°, 50 mm length of cut

21 cm
410 g

$b_{max} = 50\text{ mm}$
 $h_{max} = 5\text{ mm}$

4 033119 000582

Spare parts			Item No.	Description	EAN-Code
			3001/B	Blade LÖWE 3, 1 piece in a blister	4 033119 001206
			3001	Blade LÖWE 3, 5 pieces in a box	4 033119 001091
			3002	Anvil (base) for mitre cutter, 50 mm length of cut	4 033119 001565
			3002/0G50	Anvil (base) for 50 mm length of cut	4 033119 001824
			3002/3106	Pair of stop faces 90° for slat cutter	4 033119 002463
			1003/HU	Spring with screw and nut, for cutters with leverage (2 pieces)	4 033119 002364
			1004/HU	Pair of handles for cutters with leverage	4 033119 002357
			3005/HU	Pair of bolts with nut and sleeve, for cutters with leverage	4 033119 002340
			3006	Screw with nut for anvil (base)	4 033119 002302
			3007/HU	Set spare parts LÖWE 3 for cutters with leverage in a blister, incl.: 3001 + 3002 + 3005/HU + 3006	4 033119 002418
			3009/HU	Bolt with screw and nut, for cutters with leverage	4 033119 002395

floor layers | tilers | carpenters | window building | electrical installers
scale modeling | automotive manufacturing | heating and sanitation | leather industry
sail makers/advertising technicians | painters and upholsterers | drainage technology
workshop installation | **Cutters and spare parts** | Promotion materials



LÖWE 3.204 Tube cutter

for PVC pipes; different diameters available on request
minimum quantity: 25 pieces

21,5 cm
360 g

different diameters available on request

4 033119 000384



LÖWE 3.204/16U19 Tube cutter

for PVC pipes

21,5 cm
360 g

$\varnothing = 16\text{ mm und }19\text{ mm}$
other diameters available on request

4 033119 000346



LÖWE 3.204/P90 Tube and hose cutter

for PVC pipes and hoses

21,5 cm
370 g

$b_{max} = 45\text{ mm}$
 $h_{max} = 25\text{ mm}$
 $\varnothing_{max} = 32\text{ mm}$

4 033119 000391

Spare parts			Item No.	Description	EAN-Code
			3001/B	Blade LÖWE 3, 1 piece in a blister	4 033119 001206
			3001	Blade LÖWE 3, 5 pieces in a box	4 033119 001091
			3002/3204/16U19	Anvil (base) for tube cutter 3204/16U19	4 033119 001626
			3002/3204/P90	Anvil (base) for tube and hose cutter 3204/P90	4 033119 001619
			1003	Spring with screw and nut	4 033119 002012
			1004/04	Pair of handles for handle type 04	4 033119 002029
			1005	Bolt with sleeve and nut	4 033119 002036
			3006	Screw with nut for anvil (base)	4 033119 002302
			1009	Fastener	4 033119 002197

Cutters and Spare parts



LÖWE 3.304 Mitre Cutter

for wood, plastic and rubber materials
with stop faces at 45°, 75 mm length of cut

24,5 cm
 450 g
 $s_{max} = 75\text{ mm}$
 $h_{max} = 20\text{ mm}$
 4 033119 000247



LÖWE 3.305 Universal anvil cutter

for wood, plastic and rubber materials
75 mm length of cut

24,5 cm
 350 g
 $b_{max} = 75\text{ mm}$
 $h_{max} = 10\text{ mm}$
 $\varnothing_{max} = 40\text{ mm}$
 4 033119 000186



LÖWE 3.306 Slat cutter

for wood, plastic and rubber materials
with stop faces at 90°, 75 mm length of cut

24,5 cm
 445 g
 $b_{max} = 75\text{ mm}$
 $h_{max} = 10\text{ mm}$
 4 033119 000261

Spare parts			Item No.	Description	EAN-Code
			3001/75	Blade LÖWE 3 long, 1 piece in a blister	4 033119 001329
			3002/OG75	Anvil (base) for 75 mm length of cut	4 033119 001831
			3002/3304	Anvil (base) mitre cutter (45°) for 75 mm length of cut	4 033119 001701
			3002/3306	Anvil (base) slat cutter (90°) for 75 mm length of cut	4 033119 001718
			1003	Spring with screw and nut	4 033119 002012
			1004/04	Pair of handles for handle type 04	4 033119 002029
			1005	Bolt with sleeve and nut	4 033119 002036
			3006	Screw with nut for anvil (base)	4 033119 002302
			1009	Fastener	4 033119 002197

floor layers | tilers | carpenters | window building | electrical installers
 scale modeling | automotive manufacturing | heating and sanitation | leather industry
 sail makers/advertising technicians | painters and upholsterers | drainage technology
 workshop installation | **Cutters and spare parts** | Promotion materials



LÖWE 3.304/HU Mitre cutter

for hard and flat wood, plastic and rubber materials
with leverage, with stop faces at 45°, 75 mm length of cut

24,5 cm
 485 g
 $s_{max} = 75\text{ mm}$
 $h_{max} = 10\text{ mm}$
 4 033119 000254



LÖWE 3.305/HU Universal anvil cutter

for hard and flat wood, plastic and rubber materials
with leverage, 75 mm length of cut

24,5 cm
 380 g
 $b_{max} = 75\text{ mm}$
 $h_{max} = 5\text{ mm}$
 4 033119 000193



LÖWE 3.306/HU Slat cutter

for hard and flat wood, plastic and rubber materials
with leverage, with stop faces at 90°, 75 mm length of cut

24,5 cm
 480 g
 $b_{max} = 75\text{ mm}$
 $h_{max} = 5\text{ mm}$
 4 033119 000278

Spare parts			Item No.	Description	EAN-Code
			3001/75	Blade LÖWE 3 long, 1 piece in a blister	4 033119 001329
			3002/OG75	Anvil (base) for 75 mm length of cut	4 033119 001831
			3002/3304	Anvil (base) mitre cutter (45°) for 75 mm length of cut	4 033119 001701
			3002/3306	Anvil (base) slat cutter (90°) for 75 mm length of cut	4 033119 001718
			1003/HU	Spring with screw and nut, for cutters with leverage (2 pieces)	4 033119 002364
			1004/HU	Pair of handles for cutters with leverage	4 033119 002357
			3005/HU	Pair of bolts with nut and sleeve, for cutters with leverage	4 033119 002340
			3006	Screw with nut for anvil (base)	4 033119 002302
			3009/HU	Bolt with screw and nut, for cutters with leverage	4 033119 002395

Cutters and Spare parts

floor layers | tilers | carpenters | window building | electrical installers
 scale modeling | automotive manufacturing | heating and sanitation | leather industry
 sail makers/advertising technicians | painters and upholsterers | drainage technology
 workshop installation | **Cutters and spare parts** | Promotion materials



LÖWE 3.604 Cable duct cutter

for PVC cable and wiring conduit and plastic rails with stop faces at 45°



400 g

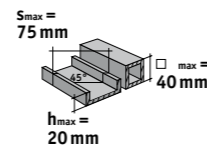

LÖWE 3.604/HU Cable duct cutter

for hard and flat PVC cable and wiring conduit and plastic rails with leverage, with stop faces at 45°



440 g

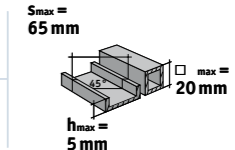

LÖWE 3.605 Cable duct cutter

for PVC cable and wiring conduit and plastic rails without stop faces



330 g

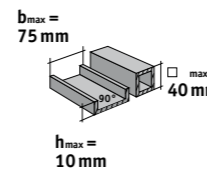

LÖWE 3.605/HU Cable duct cutter

for hard and flat PVC cable and wiring conduit and plastic rails with leverage, without stop faces



365 g

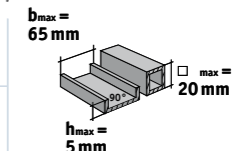

LÖWE 3.606 Cable duct cutter

for PVC cable and wiring conduit and plastic rails with stop faces at 90°



390 g

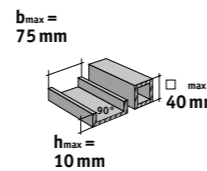

LÖWE 3.606/HU Cable duct cutter

for hard and flat PVC cable and wiring conduit and plastic rails with leverage, with stop faces at 90°



425 g

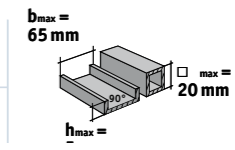

Spare parts			Item No.	Description	EAN-Code
			3001/75	Blade LÖWE 3 long, 1 piece in a blister	4 033119 001329
			3002/75K	Anvil for cable duct cutter	4 033119 001817
			3002/3604	Pair of stop faces 45° for cable duct cutter	4 033119 001725
			3002/3606	Pair of stop faces 90° for cable duct cutter	4 033119 001732
			1003	Spring with screw and nut	4 033119 002012
			1004/04	Pair of handles for handle type 04	4 033119 002029
			1005	Bolt with sleeve and nut	4 033119 002036
			1009	Fastener	4 033119 002197

Spare parts			Item No.	Description	EAN-Code
			3001/75	Blade LÖWE 3 long, 1 piece in a blister	4 033119 001329
			3002/75K	Anvil for cable duct cutter	4 033119 001817
			3002/3604	Pair of stop faces 45° for cable duct cutter	4 033119 001725
			3002/3606	Pair of stop faces 90° for cable duct cutter	4 033119 001732
			1003/HU	Spring with screw and nut, for cutters with leverage, 2 pieces	4 033119 002364
			1004/HU	Pair of handles, for cutters with leverage	4 033119 002357
			3005/HU	Pair of bolts with nut and sleeve, for cutters with leverage	4 033119 002340
			3006	Screw with nut for anvil (base)	4 033119 002302
			3009/HU	Bolt with screw and nut, for cutters with leverage	4 033119 002395

Cutters and Spare parts

floor layers | tilers | carpenters | window building | electrical installers
 scale modeling | automotive manufacturing | heating and sanitation | leather industry
 sail makers/advertising technicians | painters and upholsterers | drainage technology
 workshop installation | **Cutters and spare parts** | Promotion materials



LÖWE 3.704 Tube cutter

for cable conduits, different diameters available on request
 minimum quantity: 25 pieces

23 cm

315 g



different diameters available on request



LÖWE 3.704/16U19 Tube cutter

for cable conduits

23 cm

315 g



∅ = 16 mm and 19 mm other diameters available on request



LÖWE 3.804 Mitre cutter with trapezoidal blade

for soft wood, plastic and rubber materials
 with trapezoidal blade: quick exchange without disassembly,
 with stop faces at 45°, 50 mm length of cut

21 cm

390 g

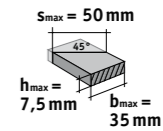

LÖWE 3.805 Universal anvil cutter with trapezoidal blade

for soft wood, plastic and rubber materials
 with trapezoidal blade: quick exchange without disassembly,
 50 mm length of cut

21 cm

350 g

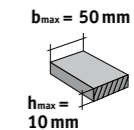

LÖWE 3.806 Flat ribbon cable cutter with trapezoidal blade

for soft wood, plastic and rubber materials
 with trapezoidal blade: quick exchange without disassembly, with stop faces at 90°

21 cm

345 g

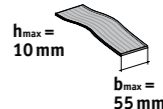

Spare parts			Item No.	Description	EAN-Code
			3001/B	Blade LÖWE 3, 1 piece in a blister	4 033119 001206
			3001	Blade LÖWE 3, 5 pieces in a box	4 033119 001091
			3002/3204/16U19	Anvil (base) for tube cutter 3204/16U19	4 033119 001626
			1003	Spring with screw and nut	4 033119 002012
			1004/04	Pair of handles for handle type 04	4 033119 002029
			1005	Bolt with sleeve and nut	4 033119 002036
			3006	Screw with nut for anvil (base)	4 033119 002302
			1009	Fastener	4 033119 002197

Spare parts			Item No.	Description	EAN-Code
			3001/TR/10	Trapezoidal blades, 10 pieces in a box	4 033119 001435
			3010	Mounting support for trapezoidal blades with rail clip and screw	4 033119 002371
			3002	Anvil (base) for mitre cutter, 50 mm length of cut	4 033119 001565
			3002/0G50	Anvil (base), for 50 mm length of cut	4 033119 001824
			3002/50K	Anvil for flat ribbon cable cutter, 50 mm length of cut	4 033119 001800
			1003	Spring with screw and nut	4 033119 002012
			1004/04	Pair of handles for handle type 04	4 033119 002029
			1005	Bolt with sleeve and nut	4 033119 002036
			1009	Fastener	4 033119 002197
			3006	Screw with nut for anvil (base)	4 033119 002302



SCAN TO GET TO THE APPLICATION VIDEOS OF OUR ORIGINAL LÖWE CUTTERS FOR PROFESSIONAL USE



Cutters and Spare parts



LÖWE 3.904/9.5 Hand eyelet press

for tarpaulins, banners and sails
suited for self-piercing eyelets in foil and tarpaulins

20 cm

435 g



Ø = 9,5 mm

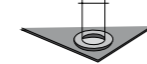

4 033119 000834



LÖWE 3.904/11 Hand eyelet press

for tarpaulins, banners and sails
suited for self-piercing eyelets in foil and tarpaulins

20 cm

470 g



Ø = 11 mm

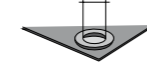

4 033119 000681

Spare parts				Item No.	Description	EAN-Code
				1003/HU	Spring with screw and nut, for cutters with leverage (2 pieces)	4 033119 002364
				1004/HU	Pair of handles for cutters with leverage	4 033119 002357
				3005/HU	Pair of bolts with nut and sleeve, for cutters with leverage	4 033119 002340
				3006	Screw with nut for anvil (base)	4 033119 002302
				3009/HU	Bolt with screw and nut, for cutters with leverage	4 033119 002395
Verbrauchsmaterial						
				0039/9.5/C	self-piercing eyelets, chromed, 9.5 mm, grommets and washers, 500 eyelets	4 033119 003033
				0039/9.5/M	self-piercing eyelets, brass, 9.5 mm, grommets and washers, 500 eyelets	4 033119 003040
				0039/11/C	self-piercing eyelets, chromed, 11 mm, grommets and washers, 500 eyelets	4 033119 003057
				0039/11/M	self-piercing eyelets, brass, 11 mm, grommets and washers, 500 eyelets	4 033119 003064

floor layers | tilers | carpenters | window building | electrical installers
scale modeling | automotive manufacturing | heating and sanitation | leather industry
sail makers/advertising technicians | painters and upholsterers | drainage technology
workshop installation | **Cutters and spare parts** | Promotion materials



LÖWE 4.104/V Cutter for sealing profiles

for window seals
V-cut, for cutting outer corners,
fold inner edge

22 cm

415 g



4 033119 000322



LÖWE 4.104/VR Cutter for sealing profiles

for window seals
V-cut, for cutting outer corners, fold inner edge,
with draw-in roller

23 cm

460 g



4 033119 000308

Spare parts			Item No.	Description	EAN-Code
			4021/V	Pair of blades LÖWE 4 V-cut (2 pieces)	4 033119 0001442
			4002	Anvil for cutter for sealing profiles without stop faces	4 033119 0001930
			4002/V	Anvil for cutter for sealing profiles 4104/V	4 033119 001596
			1003	Spring with screw and nut	4 033119 002012
			1004/04	Pair of handles for handle type 04	4 033119 002029
			1005	Bolt with sleeve and nut	4 033119 002036
			1009	Fastener	4 033119 002197
			2008	Adjusting screw for variable handle width	4 033119 002050
			4006	Screw with nut for anvil (base) LÖWE 4	4 033119 0004067
			4010/V	Cutting unit 4104/V with blades, unmounted	4 033119 002388
			4009	Draw-in roller	4 033119 002159

Cutters and Spare parts

floor layers | tilers | carpenters | window building | electrical installers
 scale modeling | automotive manufacturing | heating and sanitation | leather industry
 sail makers/advertising technicians | painters and upholsterers | drainage technology
 workshop installation | **Cutters and spare parts** | Promotion materials



LÖWE 4.104/Y Cutter for sealing profiles

for window seals
 Y-cut, for cutting inner corners



LÖWE 4.104/YR Cutter for sealing profiles

for window seals
 Y-cut, for cutting inner corners, with draw-in roller



Spare parts			Item No.	Description	EAN-Code
			4021/Y	Set of blades LÖWE 4 Y-cut (4 pieces)	4 033119 001459
			4002	Anvil for cutter for sealing profiles without stop faces	4 033119 0001930
			4002/Y	Anvil for cutter for sealing profiles 4104/Y	4 033119 001879
			1003	Spring with screw and nut	4 033119 002012
			1004/04	Pair of handles for handle type 04	4 033119 002029
			1005	Bolt with sleeve and nut	4 033119 002036
			1009	Fastener	4 033119 002197
			2008	Adjusting screw for variable handle width	4 033119 002050
			4006	Screw with nut for anvil (base) LÖWE 4	4 033119 0004067
			4010/Y	Cutting unit 4104/Y with blades, unmounted	4 033119 0002432
			4012/Y	Position brace for inner corners	4 033119 002470

INSTRUCTIONS FOR CUTTERS FOR SEALING PROFILES:

Use V-Cut | outer corner

Use Y-Cut | inner corner



1. Fix window seal and let it run down across window-frame 2. Apply cutter flush with first stop angle to window-frame, then position window seal straight on base 3. The result of the following cut is a notch in the window seal 4. Now it's possible to fix the window seal at right angles easily 5. For the final cut apply cutter with second stop angle at window seal 6. The beginning and end of the window seal meet flush

1. Fix window seal and let it run down across window-frame 2. Apply cutter flush with stop plate to window-frame, then position window seal straight on base 3. The result of the following cut is a notch in the window seal 4. With the gained rear tension release of the seal, it's possible to fix the window seal at right angles easily 5. Now the window seal can be fitted easily into the corner 6. The result is an efficient and uninterrupted inner corner of the window seal

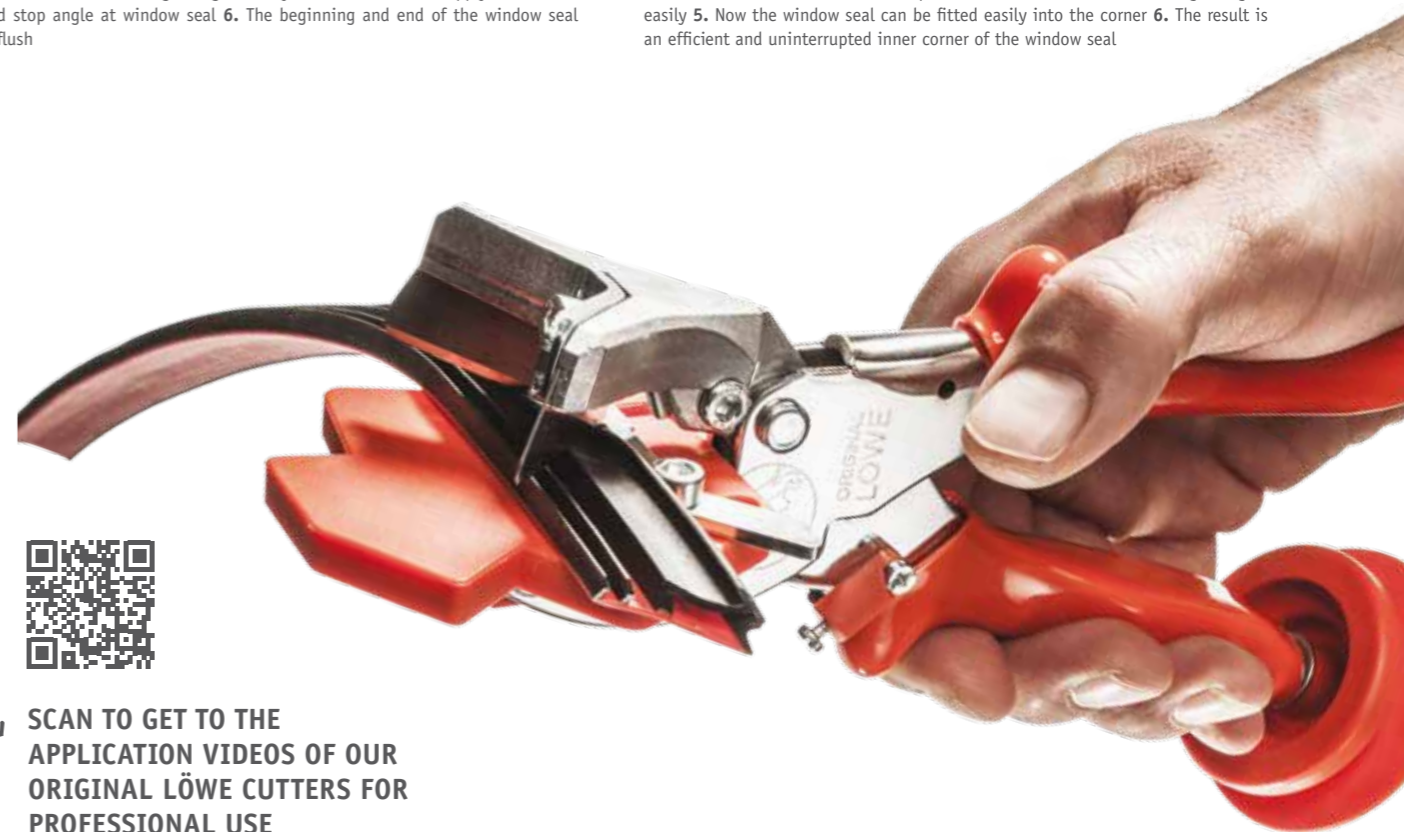

Supplier information and publisher
 Gebr. Schröder GmbH · Wischhofstr. 1-3 · D-24148 Kiel
 Tel. +49 (0)431 600 549 0 · Fax +49 (0)431 600 549 29
 e-mail info@original-loewe.de · www.original-loewe.com

Managing Director: Randolph Schröder
 Commercial register: Kiel district court
 HRB 1931 · Tax ID 19297 0323 5
 VAT ID DE134 877 364

Sizes and weights rounded to the nearest unit. All illustrations are non-binding. Subject to change and correction. Our General Terms and Conditions hereby apply. These can be viewed online at www.original-loewe.com
 May only be reproduced with the publisher's permission.

Photos: Gebr. Schröder GmbH, Oliver Franke · www.foto-oliverfranke.de, Münchow Industriefotos · Layout/Design: media4motion Werbeagentur GmbH · www.media4motion.com

Cutters and Spare parts



LÖWE 4.204 Cutter for sealing profiles

for expansion beads of facade sealing band
A-cut, reverse arrangement of the blades
compared to model 4.104



22 cm



410 g



4 033119 000698

Spare parts			Item No.	Description	EAN-Code
			4001/A	Pair of blades LÖWE 4 A-Cut (2 pieces)	4 033119 001374
			4002/A	Anvil for cutter for sealing profiles 4204	4 033119 001787
			1003	Spring with screw and nut	4 033119 002012
			1004/04	Pair of handles for handle type 04	4 033119 002029
			1005	Bolt with sleeve and nut	4 033119 002036
			1009	Fastener	4 033119 002197
			2008	Adjusting screw for variable handle width	4 033119 002050
			4006	Screw with nut for anvil (base) LÖWE 4	4 033119 004061
			4010/A	Cutting unit 4204 with blades, unmounted	4 033119 002449



floor layers | tilers | carpenters | window building | electrical installers
scale modeling | automotive manufacturing | heating and sanitation | leather industry
sail makers/advertising technicians | painters and upholsterers | drainage technology
workshop installation | **Cutters and spare parts** | Promotion materials



LÖWE 5.104/P90 Tube and hose cutter

for PVC pipes and hoses
small version



17,5 cm



200 g

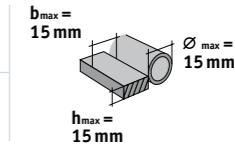

4 033119 000407

Spare parts			Item No.	Description	EAN-Code
			5001/B	Blade LÖWE 5, 1 piece in a blister	4 033119 001220
			5001	Blade LÖWE 5, 5 pieces in a box	4 033119 001381
			5002/P90	Anvil (base) for small tube and hose cutter	4 033119 001695
			1006	Screws with sleeve for anvil	4 033119 002043
			5003	Spring with screw and nut	4 033119 002128
			5004/04	Pair of handles for handle type 04	4 033119 002203
			5005	Bolt with sleeve and nut	4 033119 002135
			5009	Fastener with bolt and nut	4 033119 002210



SCAN TO GET TO THE APPLICATION VIDEOS OF OUR ORIGINAL LÖWE CUTTERS FOR PROFESSIONAL USE

Cutters and Spare parts



LÖWE 5.105 Small anvil cutter

for all materials (except for metal)
25 mm length of cut

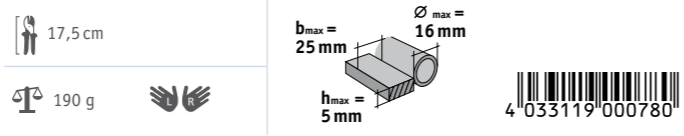

4 033119 000780



LÖWE 5.504 Hose cutter

for corrugated pipe and soft hoses
with triangular blade

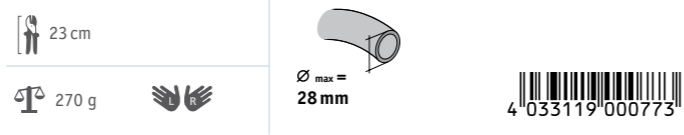

4 033119 000773

floor layers | tilers | carpenters | window building | electrical installers
scale modeling | automotive manufacturing | heating and sanitation | leather industry
sail makers/advertising technicians | painters and upholsterers | drainage technology
workshop installation | **Cutters and spare parts** | **Promotion materials**



LÖWE 50.130 Lever cutter

for large-format rails and profiles in a wide variety of materials
with stop faces at 45° and 90°

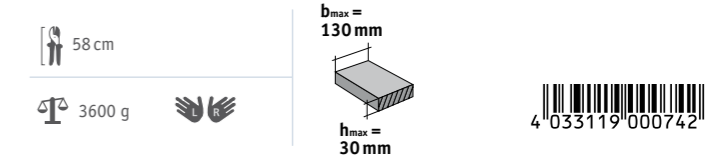

4 033119 000742



LÖWE 51.130 Lever cutter

for large-format PVC wire conduit
and hard and flat plastic rails,
with stop faces at 90°

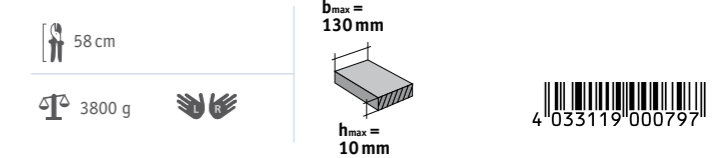

4 033119 000797

LÖWE 5.105 Spare parts			Item No.	Description	EAN-Code
			5001/B	Blade LÖWE 5, 1 piece in a blister	4 033119 001220
			5001	Blade LÖWE 5, 5 pieces in a box	4 033119 001381
			5002	Anvil (base) LÖWE 5	4 033119 001558
			5007	Set spare parts LÖWE 5 in a blister, including: 5001 + 5002 + 5003 + 5005 + 1006	4 033119 002548
			5004/04	Pair of handles for handle type 04	4 033119 002203
			1006	Screws with sleeve for anvil	4 033119 002043
			5003	Spring with screw and nut	4 033119 002128
			5005	Bolt with sleeve and nut	4 033119 002135
			5009	Fastener with bolt and nut	4 033119 002210

LÖWE 5.504 Spare parts			Item No.	Description	EAN-Code
			5031	Triangular blade LÖWE 5504	4 033119 001336
			5032	Anvil (base) for hose cutter LÖWE 5504	4 033119 001848
			5004/04	Pair of handles for handle type 04	4 033119 002203
			1006	Screws with sleeve for anvil	4 033119 002043
			5003	Spring with screw and nut	4 033119 002128
			5005	Bolt with sleeve and nut	4 033119 002135
			5009	Fastener with bolt and nut	4 033119 002210

Spare parts		Item No.	Description	EAN-Code
		50.001	Blade LÖWE 50/51, 1 piece in a blister	4 033119 001275
		50.002	Anvil (base) LÖWE 50.130	4 033119 001893

Sharpener	Item No.	Description	EAN-Code
	0021	Sharpener	4 033119 003019

LÖWE Promotion materials		Item No.	Description	EAN-Code
			Banner, different styles to select dimension: 500 x 1800 mm	
		9931	Brochure cutters for industry and trade	4 033119 003453
		9920	Sample case of cutters for industry and trade 21 spaces, without content	4 033119 003231
		9909	Selling display for 30 cutters	4 033119 003248
		9938	Sticker logo + LÖWE 3 dimension: 385 x 90 mm	4 033119 003361
		9926	Small sticker logo dimension: 210 x 75 mm	4 033119 003316

No discounts available for promotion materials.

 Made in Germany since 1923



ORIGINAL
LÖWE

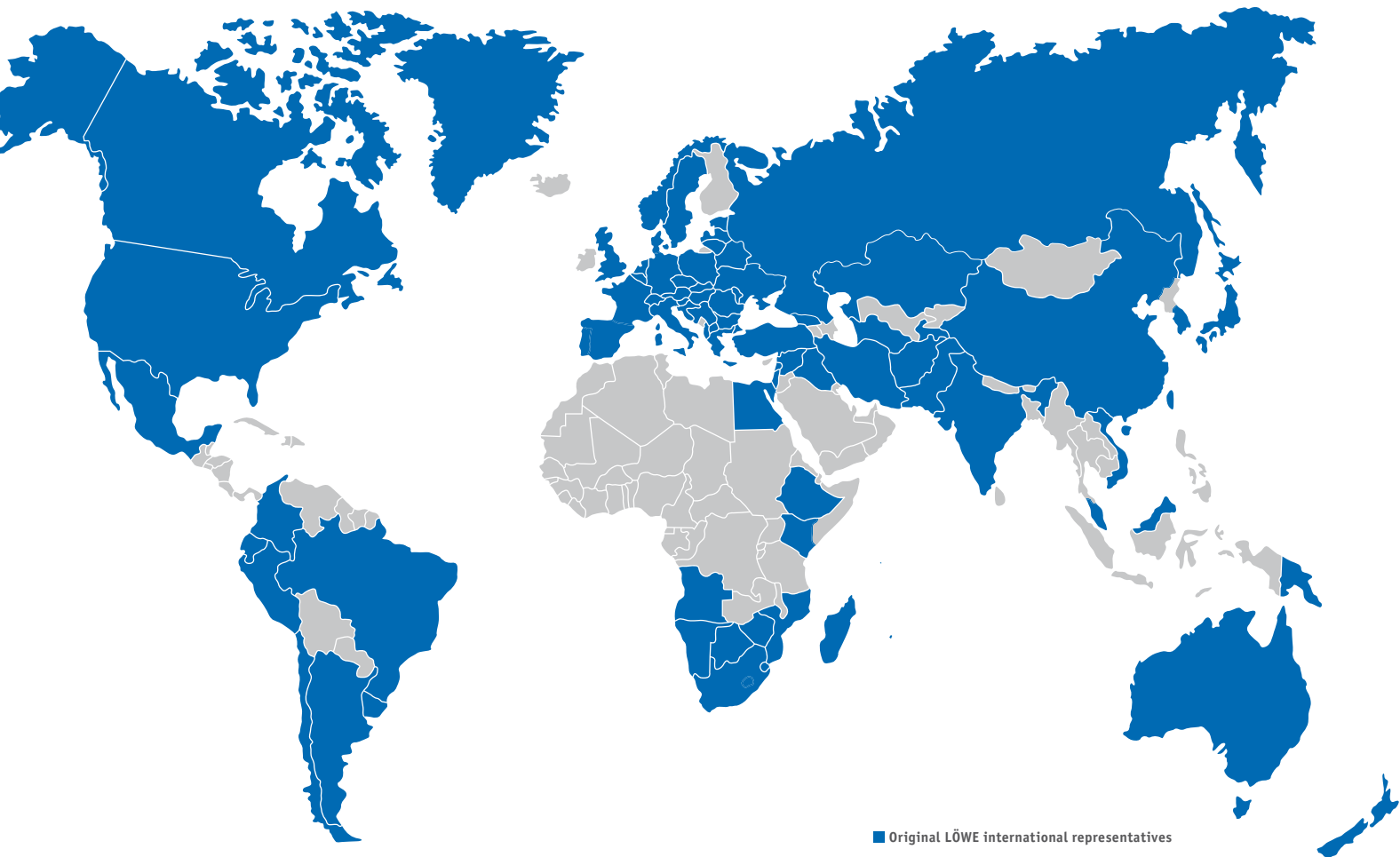

■ Original LÖWE international representatives

ORIGINAL LÖWE INTERNATIONAL DISTRIBUTORS

Our international distributors and encouraged dealers take good care for a worldwide availability of our products in more than 90 countries, providing our Original LÖWE products – top class pruners, loppers and cutting tools.

Please find the contacts in alphabetical order per country on our website:

www.original-loewe.com/distribution-partners.



SCAN AND FIND YOUR DISTRIBUTION PARTNER OUT OF OVER 90 COUNTRIES WORLDWIDE.

Your Original LÖWE dealer

You're interested in our Original LÖWE pruning shears or you have any questions? We will gladly answer all your questions on the phone +49 (0) 431 600 549 0 or via e-mail: info@original-loewe.de

Quality prevails.
Original LÖWE, made in Germany since 1923.



Gebr. Schröder GmbH
Wischhofstr. 1-3 · D-24148 Kiel
fon +49 (0) 431 600 549 0
fax +49 (0) 431 600 549 29
info@original-loewe.de



www.original-loewe.com

find us on facebook: Original Loewe