

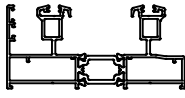

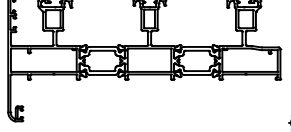

PROFİL VE AKSESUAR LİSTELERİ
PROFILE & ACCESSORIES LISTS

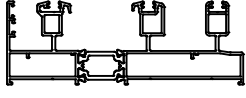

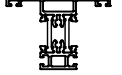
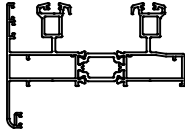
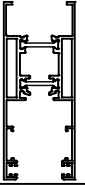
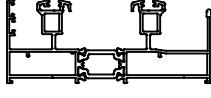
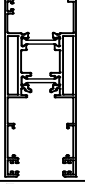
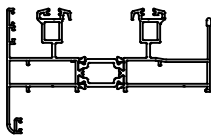
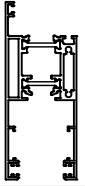
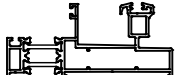

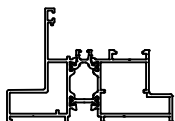
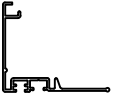
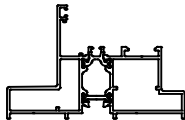
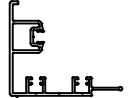
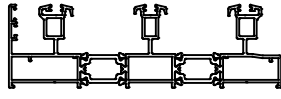

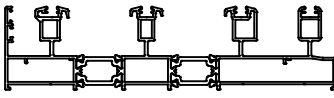
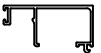



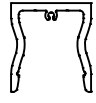

PROFİL LİSTESİ - PROFILES LIST

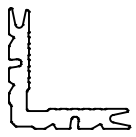

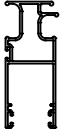















SL38T 10			SL38T 102		
KALDIR-SÜR SİSTEM KASA PROFİLİ <i>LIFT&SLIDE FRAME PROFILE</i>	AĞIRLIK / Weight 1,809 kg/mt		KALDIR-SÜR ÜÇLÜ KASA PROFİLİ <i>LIFT&SLIDE FRAME PROFILE</i>	AĞIRLIK / Weight 2,801 kg/mt	
SL38T 10F			SL38T 21		
KALDIR-SÜR SİSTEM SİNEKLİKLİ KASA <i>LIFT&SLIDE FRAME PROFILE WITH FLYSCREEN</i>	AĞIRLIK / Weight 2,245 kg/mt		ORTA KAYIT PROFİLİ <i>TRANSOM-MULLION PROFILE</i>	AĞIRLIK / Weight 0,904 kg/mt	
SL38T 103			SL38T 12		
KALDIR-SÜR SİSTEM PERVAZLI KASA PROFİLİ <i>LIFT&SLIDE FRAME PROFILE</i>	AĞIRLIK / Weight 1,929 kg/mt		KANAT PROFİLİ <i>SASH PROFILE</i>	Jx cm ⁴ 35,69	
SL38T 104			SL38T 17		
KALDIR-SÜR SİSTEM SİNEKLİKLİ KASA <i>LIFT&SLIDE FRAME PROFILE WITH FLYSCREEN</i>	AĞIRLIK / Weight 1,987 kg/mt		KANAT PROFİLİ <i>SASH PROFILE</i>	Jx cm ⁴ 35,72	
SL38T 105			SL38T 16		
KALDIR-SÜR SİNEKLİKLİ PERVAZLI KASA <i>LIFT&SLIDE FRAME PROFILE WITH FLYSCREEN</i>	AĞIRLIK / Weight 2,107 kg/mt		ÇİTALI KANAT PROFİLİ <i>SASH PROFILE</i>	Jx cm ⁴ 33,11	
SL38T 09			SL38T 20		
SABİTLİ KASA PROFİLİ <i>MONORAIL FRAME PROFILE</i>	AĞIRLIK / Weight 1,476 kg/mt		CAM ÇİTA PROFİLİ <i>GLAZING BEAD PROFILE</i>	AĞIRLIK / Weight 0,102 kg/mt	
SL38T 552			SL38T 42		
TH55 SİSTEM GEÇİŞ PROFİLİ-SL38T 09 İÇİN <i>FRAME PROFILE FOR SL38T 09</i>	AĞIRLIK / Weight 1,558 kg/mt		KENET PROFİLİ <i>CENTRAL LOCKING PROFILE</i>	AĞIRLIK / Weight 0,495 kg/mt	
SL38T 55			SL38T 45		
TH55 SİSTEM GEÇİŞ PROFİLİ-SL38T 10 İÇİN <i>FRAME PRO. FOR SL38T 10</i>	AĞIRLIK / Weight 1,613 kg/mt		3'LÜ KANAT ADAPTÖR PROFİLİ <i>ADAPTER PROFILE</i>	AĞIRLIK / Weight 0,804 kg/mt	
SL38T 101			SL38T 43		
KALDIR-SÜR SİSTEM ÜÇLÜ KASA PROFİLİ <i>FRAME PROFILE</i>	AĞIRLIK / Weight 2,681 kg/mt		ADAPTÖR PROFİLİ <i>ADAPTER PROFILE</i>	AĞIRLIK / Weight 0,615 kg/mt	
SL38T 101F			SL38T 46		
KALDIR-SÜR SİSTEM SİNEKLİKLİ KASA <i>LIFT&SLIDE FRAME PRO. WITH FLYSCREEN</i>	AĞIRLIK / Weight 3,119 kg/mt		KAPAK PROFİLİ <i>COVER PROFILE</i>	AĞIRLIK / Weight 0,427 kg/mt	

✳ Sipariş öncesi kalıp bilgisi kontrol edilmeli / *must be check profile mold before the order*

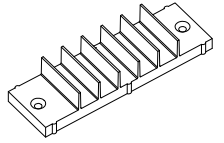

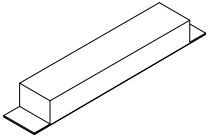
Profil ağırlıklarımız teorik olup, teslim anındaki tartımız geçerlidir.
Profile weights are theoretical and the weight at the time of delivery is valid.

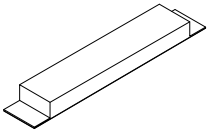

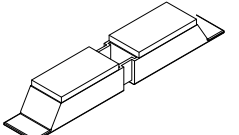
PROFİL LİSTESİ - PROFILES LIST

SL38T 47			LS60 71		
KALDIR-SÜR KİLİTLEME ADAPTÖR PROFİLİ (PRES) <i>LIFT&SLIDE LOCK ADAPTER</i>	AĞIRLIK / Weight 0,520 kg/mt		KANAT SABİTLEME PROFİLİ <i>SASH FIXING PROFILE</i>	AĞIRLIK / Weight 2,050 kg/mt	
12-41			LS60 72		
TİJ PROFİLİ <i>SASH PROFILE</i>	AĞIRLIK / Weight 0,118 kg/mt		KULP KAPAK PROFİLİ <i>HANDLE COVER PROFILE</i>	AĞIRLIK / Weight 0,420 kg/mt	
15-304216-09			10-010106-00		
SİNEKLİK KANAT PROFİLİ <i>FLYSCREEN SASH PROFILE</i>	AĞIRLIK / Weight 0,352 kg/mt		KÖŞE TAKOZU-10,6 mm <i>CORNER JOINT</i>	AĞIRLIK / Weight 2,491 kg/mt	
15-306317-11					
SİNEKLİK KANAT PROFİLİ <i>FLYSCREEN SASH PROFILE</i>	AĞIRLIK / Weight 0,561 kg/mt				
13-09986					
SİNEKLİK KANAT PROFİLİ <i>FLYSCREEN SASH PROFILE</i>	AĞIRLIK / Weight 0,741 kg/mt				
SL38T 61					
SİNEKLİK RAY PROFİLİ <i>FLYSCREEN RAIL PROFILE</i>	AĞIRLIK / Weight 0,185 kg/mt				
12-54					
PERVAZ PROFİLİ <i>BORDER PROFILE</i>	AĞIRLIK / Weight 0,326 kg/mt				
12-61					
ALÜMİNYUM RAY PROFİLİ <i>ALUMINIUM RAIL PROFILE</i>	AĞIRLIK / Weight 0,111 kg/mt				
SL38T 35					
KANAT SABİTLEME PROFİLİ <i>SASH FIXING PROFILE</i>	AĞIRLIK / Weight 0,651 kg/mt				
SL-1515					
KULP PROFİLİ <i>HANDLE PROFILE</i>	AĞIRLIK / Weight 0,092 kg/mt				

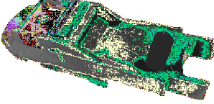
EP1-01			KF 67-650		
DIŞ CAM FİTİLİ - 2,5 mm OUTER GLAZING GASKET	KOLİ MİKTARI/Package 240 mt / 15 kg		FİRÇA FİTİL - 7 mm BRUSH GASKET	KOLİ MİKTARI/Package 1200 mt	
EP2-01			KF 67-700		
İÇ CAM FİTİLİ - 3 mm INNER GLAZING GASKET	KOLİ MİKTARI/Package 440 mt / 15 kg		FİRÇA FİTİL - 7 mm BRUSH GASKET	KOLİ MİKTARI/Package 1200 mt	
EP2-02			SL38T-PLZ 04		
İÇ CAM FİTİLİ - 4 mm INNER GLAZING GASKET	KOLİ MİKTARI/Package 300 mt / 15 kg		ORTA KENET YALITIM FİTİLİ - PVC CENTRAL LOCKING SEALING GASKET-PVC	KOLİ MİKTARI/Package 6 mt / adet	
EP2-03					
İÇ CAM FİTİLİ - 5 mm INNER GLAZING GASKET	KOLİ MİKTARI/Package 250 mt / 15 kg				
KC 02			SL38T-PLZ 03		
CAM FİTİLİ - 2 mm GLAZING GASKET	KOLİ MİKTARI/Package 100 mt / 4,5 kg		KALDIR-SÜR RULMAN DESTEK PROFİLİ - PVC PVC PROFILE FOR LIFT&SLIDE ROLLER	KOLİ MİKTARI/Package 6 mt / adet	
EP38-01			SL38T-PLU		
KANAT FİTİLİ SASH GASKET	KOLİ MİKTARI/Package 500 mt / 15 kg		KASA YALITIM PVC FRAME ISOLATION GASKET	KOLİ MİKTARI/Package 6 mt/adet	
EP38-02			SL38T-SFP 01		
KASA KANAL FİTİLİ FRAME GASKET	KOLİ MİKTARI/Package 535 mt / 15 kg		ALT HAVA KESİCİ EPDM BOTTOM WEATHER PROTECTOR	KOLİ MİKTARI/Package Adet / Piece	
EP38-03			SL38T-SFP 02		
SABİT ÇITA FİTİLİ FIXED FRAME GASKET	KOLİ MİKTARI/Package 145 mt / 13 kg		ÜST HAVA KESİCİ SÜNGER TOP WEATHER SEALING-PROTECTOR	KOLİ MİKTARI/Package Adet / Piece	
EP38-05			SL38T-SFP 03		
KANAT FİTİLİ SASH GASKET	KOLİ MİKTARI/Package - mt / -kg		ÜST HAVA KESİCİ SÜNGER - SL38T 09 İÇİN CENTRAL SEALING-TOP FOR SL38T 09	KOLİ MİKTARI/Package Adet / Piece	
KF 67-550			SL38T-SFP 04		
FİRÇA FİTİLİ - 5,5 mm BRUSH GASKET	KOLİ MİKTARI/Package 1400 mt		ALT HAVA KESİCİ SL38T 09 KASA İÇİN CENTRAL SEALING-BOTTOM FOR SL38T 09	KOLİ MİKTARI/Package Adet / Piece	

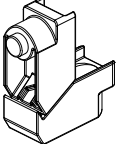
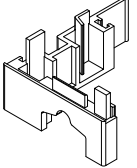
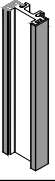
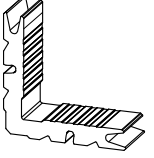
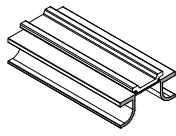
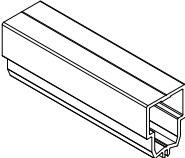
AKSESUAR LİSTESİ - ACCESSORIES LIST

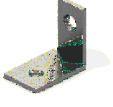
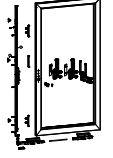
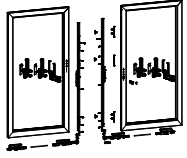
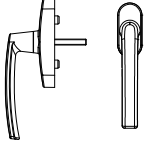
SL38T-PLU 02			ASI-SL1520		
İSPANYOLET ADAPTÖR FİTİLİ - PVC MULTI POINT LOCK SEALING GASKET-PVC	KOLİ MİKTARI/Package 6 mt / adet		KASA MONTAJ PARÇASI FRAME ASSEMBLY PART	KOLİ MİKTARI/Package Adet / Piece	
ASI-STP 06			ASI-5025		
KANAT DENGELEME VE STOPER AKSESUARI SASH STOPPER & STABILIZATION	KOLİ MİKTARI/Package Adet / Piece		SİNEKLİK FİTİLİ FLYSCREEN GASKET	KOLİ MİKTARI/Package 100 mt	
SL38T-KP 03			ASI-BZ 5060		
SL38T 43 İÇİN KAPAK PLASTIC END COVER FOR SL38T 43	KOLİ MİKTARI/Package Adet / Piece		SİNEKLİK KANAT RULMANI ROLLER FOR FLYSCREEN SASH	KOLİ MİKTARI/Package Adet / Piece	
SL38T-KP 04 SAĞ			ASI-BZ 5007		
DÜZ KENET KAPAĞI-ÜST FLAT INTERLOCK PROFILE CAP - TOP / RIGHT	KOLİ MİKTARI/Package Adet / Piece		SİNEKLİK PROFİLİ KÖŞE BAĞLANTI CORNER JOINT FOR FLYSCREEN SASH	KOLİ MİKTARI/Package 100 Adet	
SL38T-KP 04 SOL			ASI-PB 1119		
DÜZ KENET KAPAĞI-ÜST FLAT INTERLOCK PROFILE CAP - TOP / LEFT	KOLİ MİKTARI/Package Adet / Piece		KÖŞE BAĞLANTI CORNER JOINT	KOLİ MİKTARI/Package 250 Adet	
SL38T-KP 05 SAĞ			ASI-PB 1124		
DÜZ KENET KAPAĞI-ALT FLAT INTERLOCK PROFILE CAP - BOTTOM / RIGHT	KOLİ MİKTARI/Package Adet / Piece		KÖŞE BAĞLANTI CORNER JOINT	KOLİ MİKTARI/Package 250 Adet	
SL38T-KP 05 SOL			ASI-CC 1220		
DÜZ KENET KAPAĞI-ALT FLAT INTERLOCK PROFILE CAP - BOTTOM / LEFT	KOLİ MİKTARI/Package Adet / Piece		ÖZEL KÖŞE BAĞLANTI CORNER JOINT	KOLİ MİKTARI/Package Adet	
SL38T-LS1			ASI-KT 1124		
KALDIR-SÜR SİSTEM İSPANYOLET DESTEĞİ LIFT&SLIDE LOCKING SUPPORT	KOLİ MİKTARI/Package Adet / Piece		KÖŞE BAĞLANTI CORNER JOINT	KOLİ MİKTARI/Package Adet / Piece	
SL38T-LS2			ASI-PB 19		
KALDIR-SÜR SİSTEM RULMAN DESTEĞİ LIFT&SLIDE ROLLER SUPPORT	KOLİ MİKTARI/Package Adet / Piece		KÖŞE GÖNYESİ CORNER ALIGNMENT	KOLİ MİKTARI/Package 1000 Adet	
SL38T-DB100			ASI-MO21		
KANAT SABİTLEME PARÇASI SASH FIXING	KOLİ MİKTARI/Package Adet / Piece		PLASTİK KÖŞE GÖNYESİ CORNER ALIGNMENT	KOLİ MİKTARI/Package Adet / Piece	

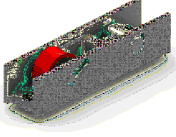
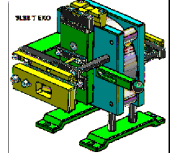
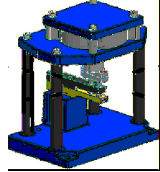
ASI-P 100.1				
ORTA KAYIT BAĞLANTI T JOINT FIXING	KOLİ MİKTARI/Package 250 Adet / Piece			
SL38T-MEK1				
200 kg KAPASİTELİ KALDIR-SÜR MEKANİZMA LIFT & SLIDE MECHANISM	KOLİ MİKTARI/Package Takım / Set			
SL38T-MEK1D				
4'LÜ KANAT KALDIR-SÜR MEKANİZMA - 200kg LIFT & SLIDE MECHANISM	KOLİ MİKTARI/Package Takım / Set			
ASI-WH 002				
İSPANYOLET KİLİTLEME KOL MULTI POINT LOCK HANDLE	KOLİ MİKTARI/Package Adet / Piece			
ASI-SH 008				
ÇEKME HAVUZ KOL PULL EMBEDDED HANDLE	KOLİ MİKTARI/Package Adet / Piece			
ASI-INR 01				
ÇELİK RAY STEEL RAIL	KOLİ MİKTARI/Package 3,5 mt / Adet			
ASI-SR 01R				
AYARLI TEKLİ RULMAN (V TİPİ RAY İÇİN) SINGLE SLIDING ROLLER FOR RAIL TYPE - V	KOLİ MİKTARI/Package Adet / Piece			
SL38T EKO PANÇ				
45° KANAT TOPLAMA PANÇ MAKİNESİ PUNCH MACHINE FOR CORNER 45° SASH	KOLİ MİKTARI/Package Adet / Piece			
501 EKO PANÇ				
KÖŞE PİMLİ BAĞLANTI PANÇ MAKİNESİ PUNCH MACHINE FOR CORNER JOINT WITH PIN	KOLİ MİKTARI/Package Adet / Piece			

SL38T - K

YALITIMLI KALDIR-SÜR SİSTEM
THERMAL LIFT&SLIDE SYSTEM

ASISTAL

PROFİL DETAYLARI
PROFILE DETAILS



SL38T-K

YALITIMLI KALDIR-SÜR SİSTEM
THERMAL LIFT&SLIDE SYSTEM

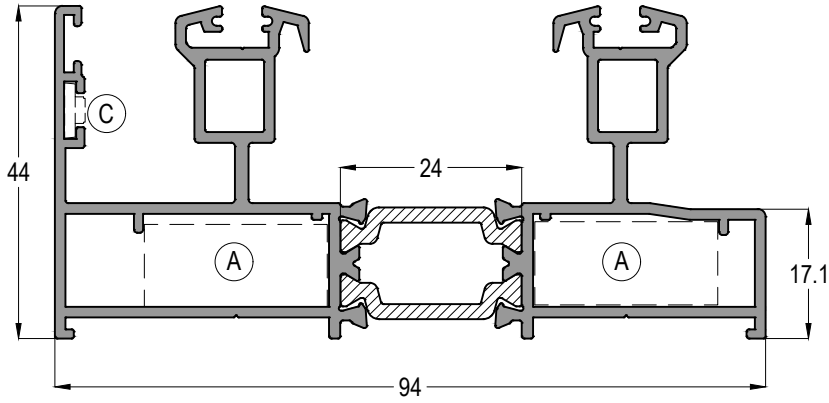
ASISTAL



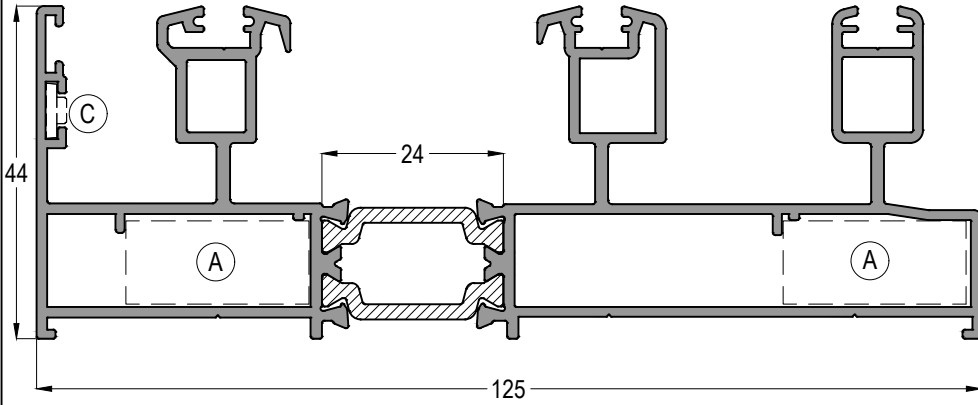

SL38T 10

		AĞIRLIK / Weight
ASI-PB 1124 - ASI-KT 1124	ASI-PB 19	1,809 kg/mt



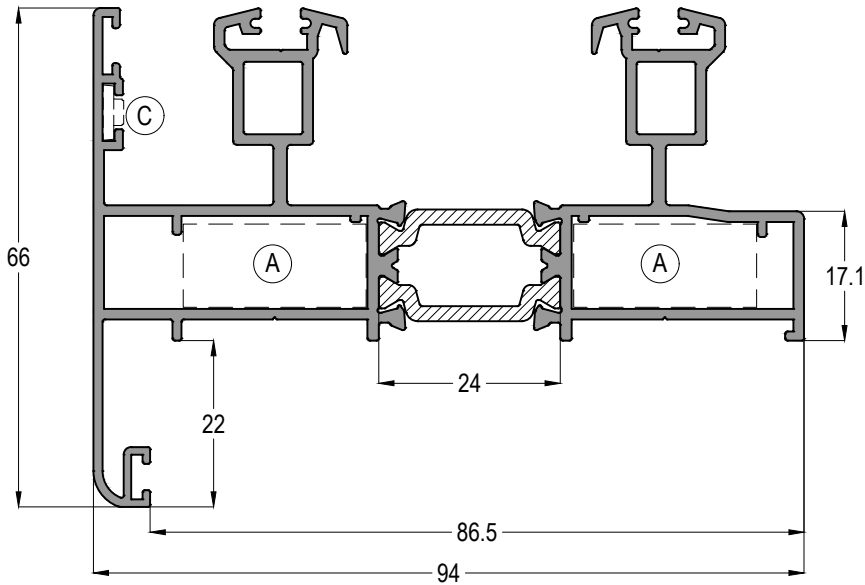

SL38T 10F

		AĞIRLIK / Weight
ASI-PB 1124 - ASI-KT 1124	ASI-PB 19	2,245 kg/mt



SL38T 103

		AĞIRLIK / Weight
ASI-PB 1124 - ASI-KT 1124	ASI-PB 19	1,929 kg/mt

⊛ Sipariş öncesi kalıp bilgisi kontrol edilmeli / profile mold must be checked before the order

Profil ağırlıklarımız teorik olup; teslim anındaki tartımız geçerlidir.
Profile weights are theoretical and the weight at the time of delivery is valid.

SL38T-K

YALITIMLI KALDIR-SÜR SİSTEM
THERMAL LIFT&SLIDE SYSTEM

ASISTAL

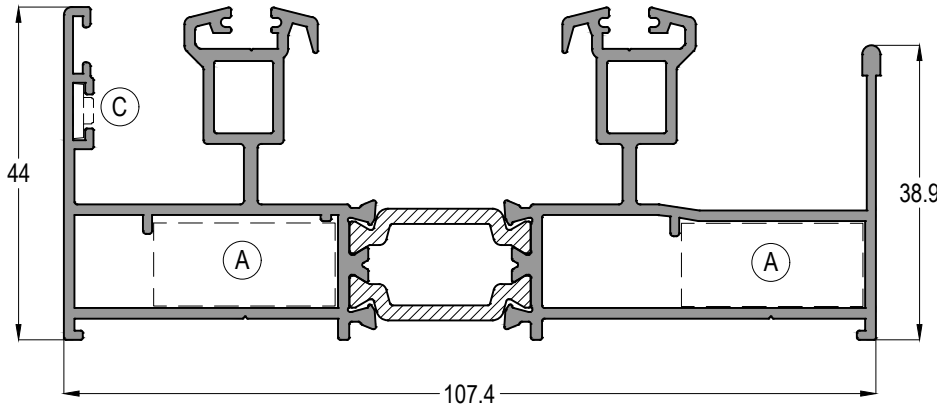

SL38T 104

		AĞIRLIK / Weight 1,987 kg/mt
ASI-PB 1124 - ASI-KT 1124	ASI-PB 19	

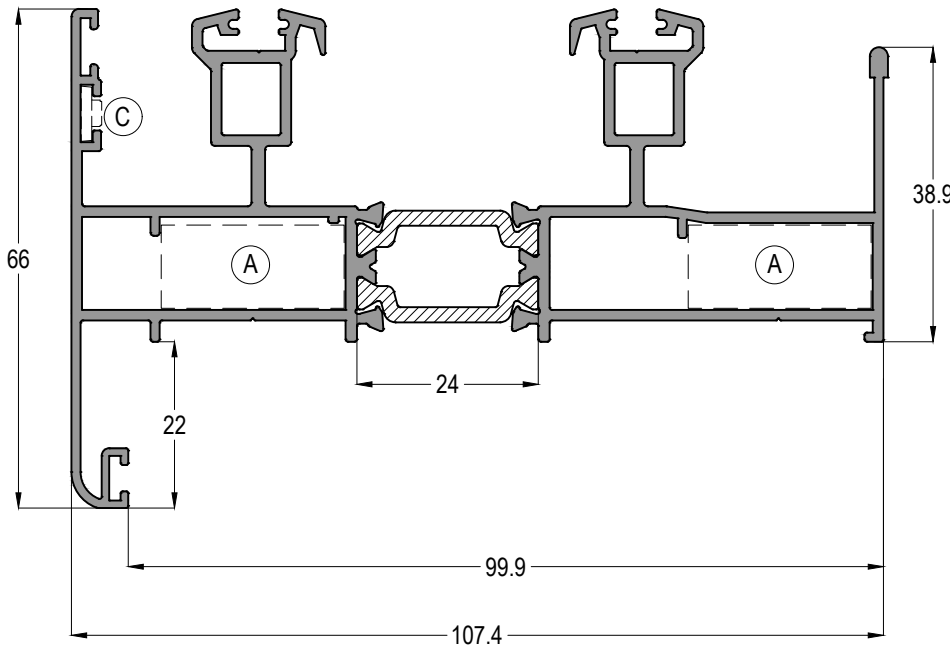

SL38T 105

		AĞIRLIK / Weight 2,107 kg/mt
ASI-PB 1124 - ASI-KT 1124	ASI-PB 19	

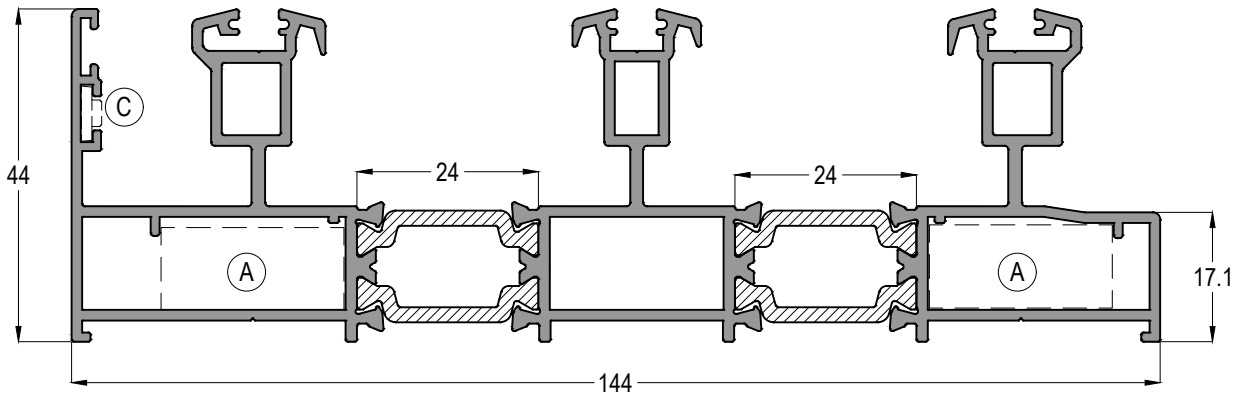

SL38T 101

		AĞIRLIK / Weight 2,681 kg/mt
ASI-PB 1124 - ASI-KT 1124	ASI-PB 19	

⚠ Sipariş öncesi kalıp bilgisi kontrol edilmeli / *profile mold must be checked before the order*

Profil ağırlıklarımız teorik olup; teslim anındaki tartımız geçerlidir.
Profile weights are theoretical and the weight at the time of delivery is valid.

SL38T-K

YALITIMLI KALDIR-SÜR SİSTEM
THERMAL LIFT&SLIDE SYSTEM

ASISTAL

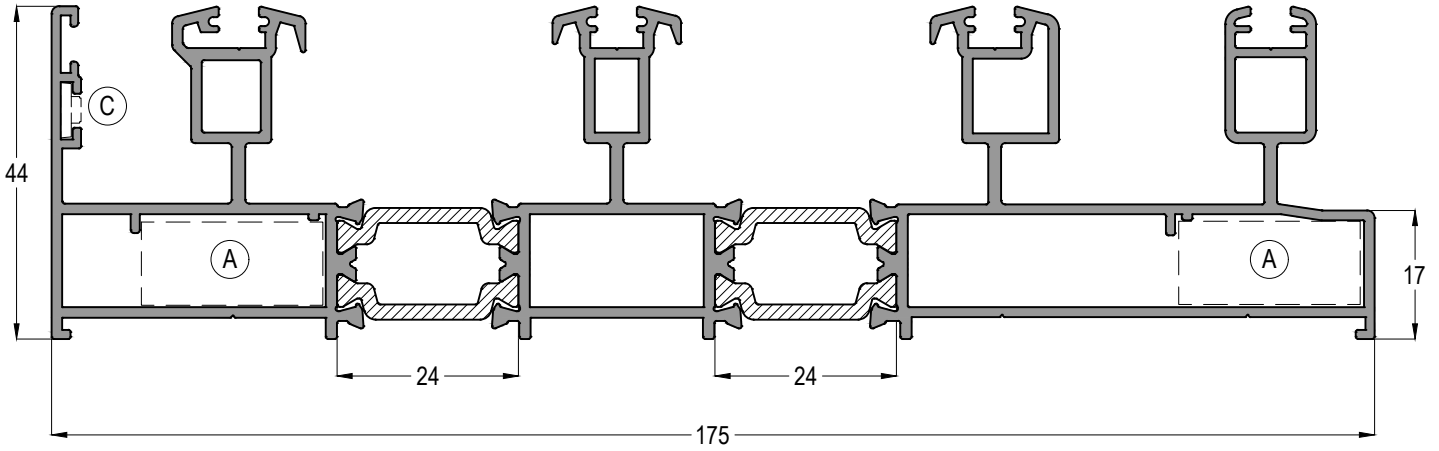

SL38T 101F

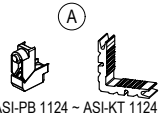
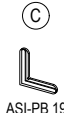
		AĞIRLIK / Weight
ASI-PB 1124 ~ ASI-KT 1124	ASI-PB 19	3,119 kg/mt

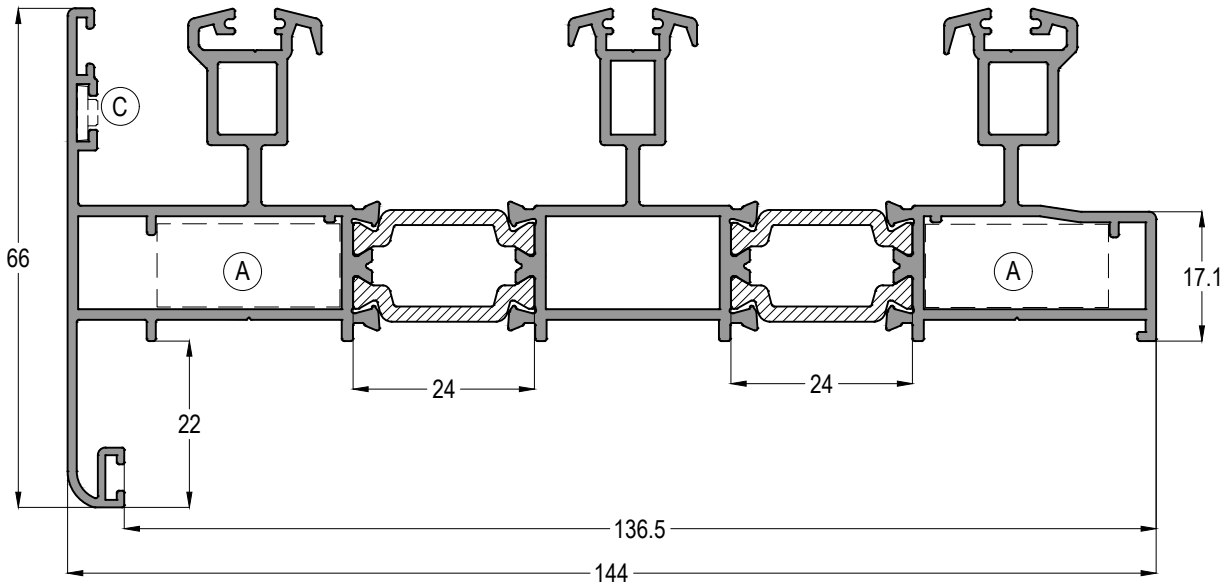

SL38T 102

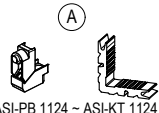
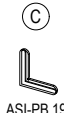
		AĞIRLIK / Weight
ASI-PB 1124 ~ ASI-KT 1124	ASI-PB 19	2,801 kg/mt

⊗ Sipariş öncesi kalıp bilgisi kontrol edilmeli / profile mold must be checked before the order

Profil ağırlıklarımız teorik olup; teslim anındaki tartımız geçerlidir.
Profile weights are theoretical and the weight at the time of delivery is valid.



SL38T-K

YALITIMLI KALDIR-SÜR SİSTEM
THERMAL LIFT&SLIDE SYSTEM

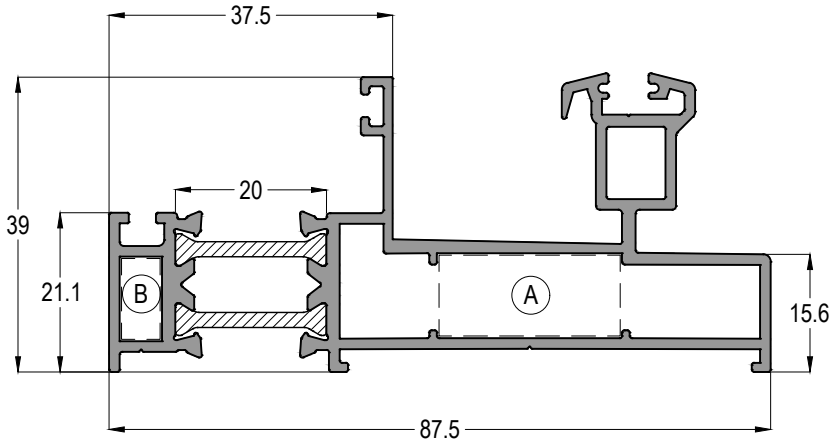
ASISTAL

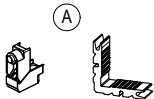

SL38T 09

		AĞIRLIK / Weight
ASI-PB 1124 - ASI-KT 1124	ASI-KT 1105	1,476 kg/mt

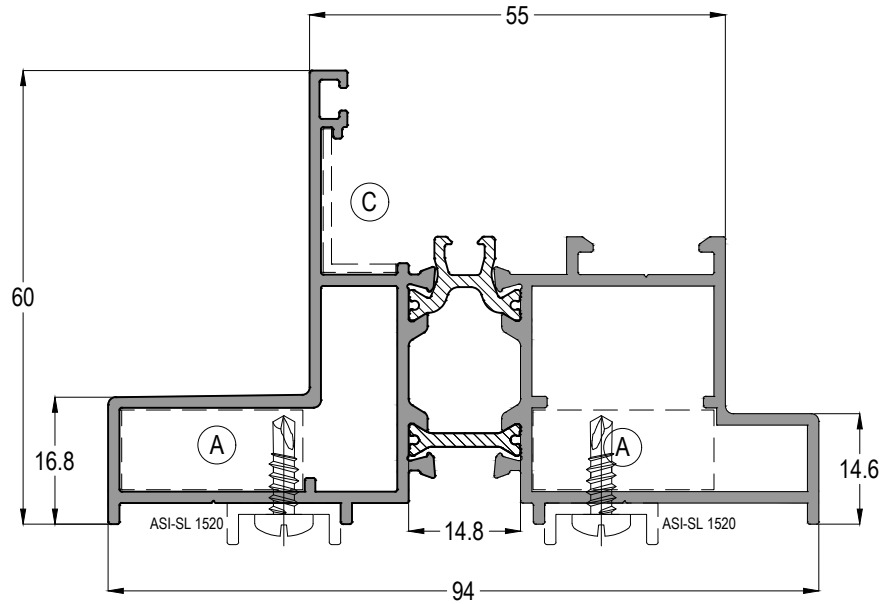

SL38T 55

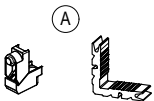
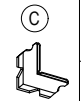
		AĞIRLIK / Weight
ASI-PB 1124 - ASI-KT 1124	ASI-MO 21	1,613 kg/mt

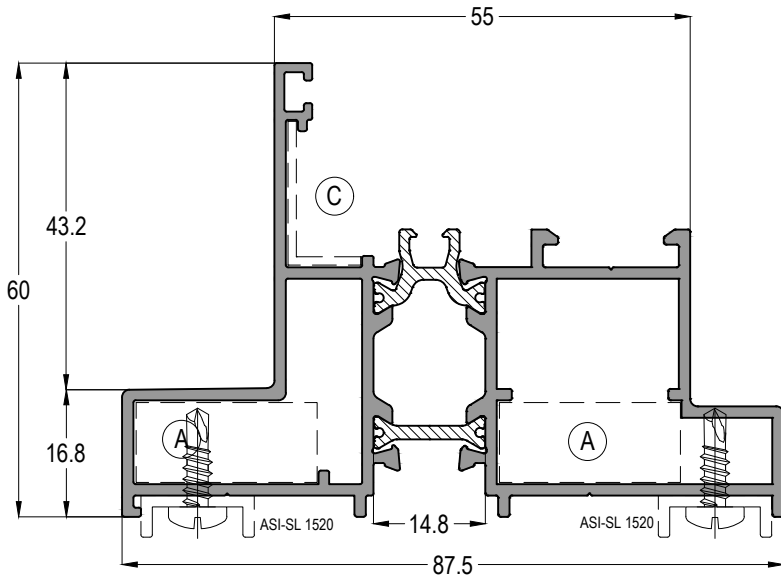

SL38T 552

		AĞIRLIK / Weight
ASI-PB 1124 - ASI-KT 1124	ASI-MO 21	1,558 kg/mt

⚠ Sipariş öncesi kalıp bilgisi kontrol edilmeli / profile mold must be checked before the order

Profil ağırlıklarımız teorik olup; teslim anındaki tartımız geçerlidir.
Profile weights are theoretical and the weight at the time of delivery is valid.

SL38T-K

YALITIMLI KALDIR-SÜR SİSTEM
THERMAL LIFT&SLIDE SYSTEM

ASISTAL

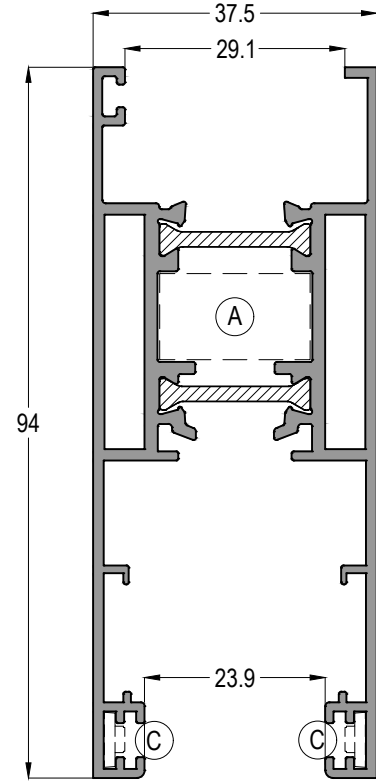
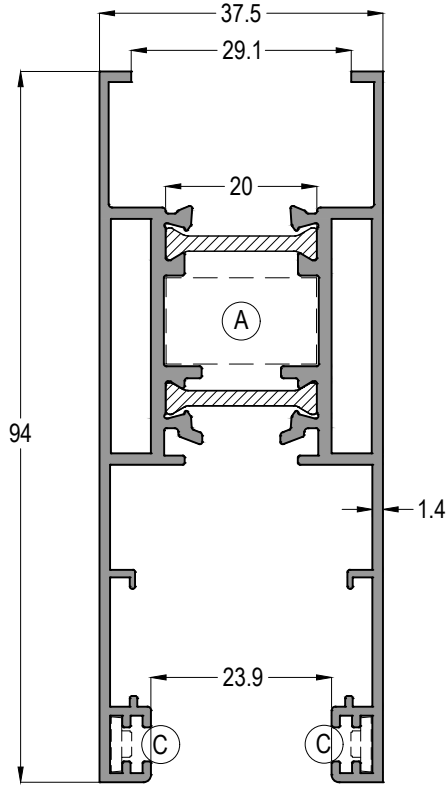

SL38T 12		Jx cm ⁴	Jy cm ⁴
		35,69	12,62
AĞIRLIK / Weight			
1,615 kg/mt			

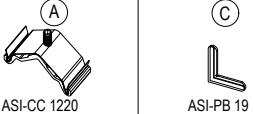

SL38T 17		Jx cm ⁴	Jy cm ⁴
		35,72	12,62
AĞIRLIK / Weight			
1,630 kg/mt			

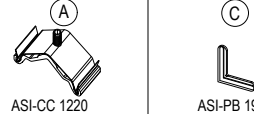

SL38T 16		Jx cm ⁴	Jy cm ⁴
		33,11	11,76
AĞIRLIK / Weight			
1,618 kg/mt			



SL38T 12 KANAT İÇİN

FOR SL38T 12 SASH

CAM KALINLIĞINA GÖRE CAM SEÇİM
TABLOSU
Glazing Selection Table according to the
Glass Thickness

CAM KALINLIĞI Glass Thickness (mm)	İÇ CAM FİTİLİ Glass Gasket (IN)	DIŞ CAM FİTİLİ Glass Gasket (OUT)
18	EP2-03	EP2-03
20	EP2-02	EP2-02
22	EP2-01	EP2-01
24	KC-02	KC-02

SL38T 16 ve 17 NOLU KANATLAR İÇİN

FOR SL38T 16 & 17 SASHES

CAM KALINLIĞINA GÖRE CAM SEÇİM
TABLOSU
Glazing Selection Table according to the
Glass Thickness

CAM KALINLIĞI Glass Thickness (mm)	İÇ CAM FİTİLİ Glass Gasket (IN)	DIŞ CAM FİTİLİ Glass Gasket (OUT)
20	EP2-03	EP1-01
22	EP2-02	EP1-01
24	KC-02	EP1-01

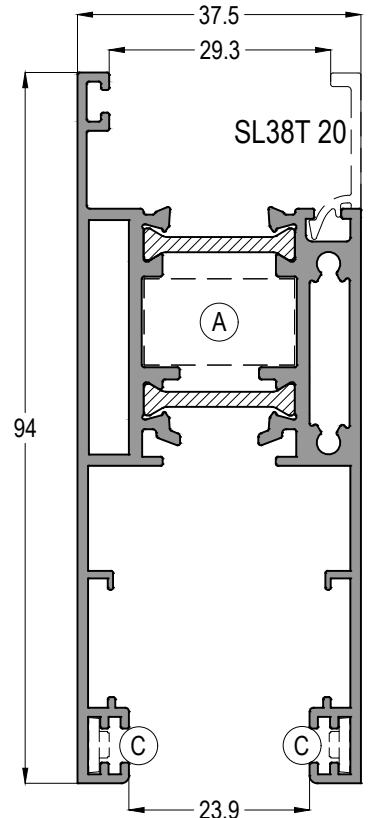

Profil ağırlıklarımız teorik olup; teslim anındaki tartımız geçerlidir.
Profile weights are theoretical and the weight at the time of delivery is valid.

SL38T-K

YALITIMLI KALDIR-SÜR SİSTEM
THERMAL LIFT&SLIDE SYSTEM

ASISTAL

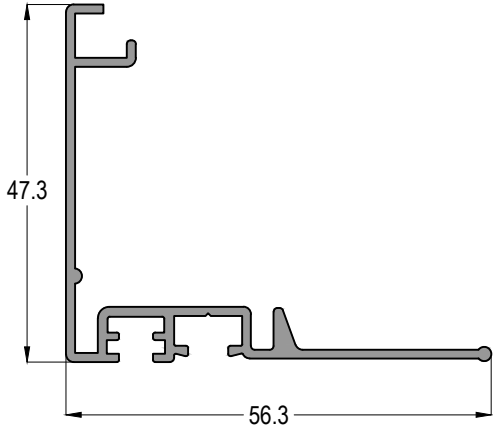

SL38T 42

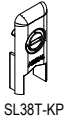

SL38T-KP

AĞIRLIK / Weight

0,495 kg/mt

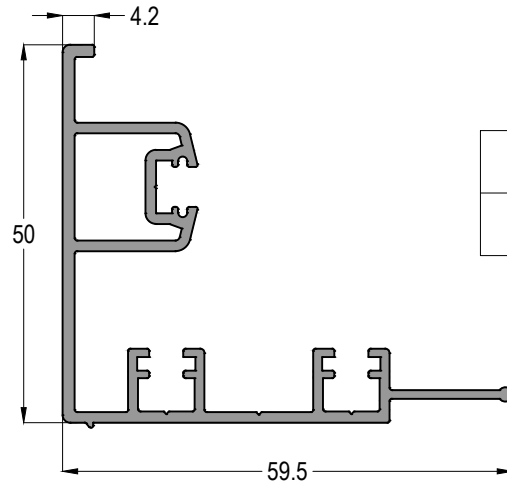

SL38T 45

0,804 kg/mt

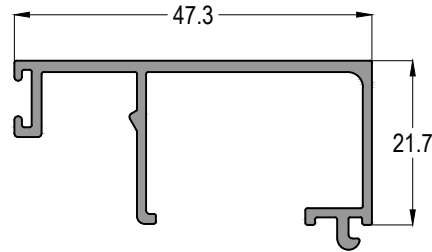

SL38T 46

0,437 kg/mt

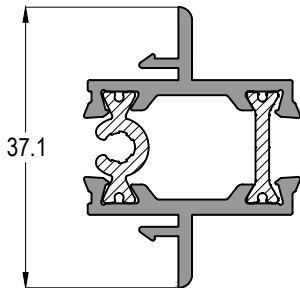

SL38T 43



SL38T-KP 03

AĞIRLIK / Weight

0,615 kg/mt

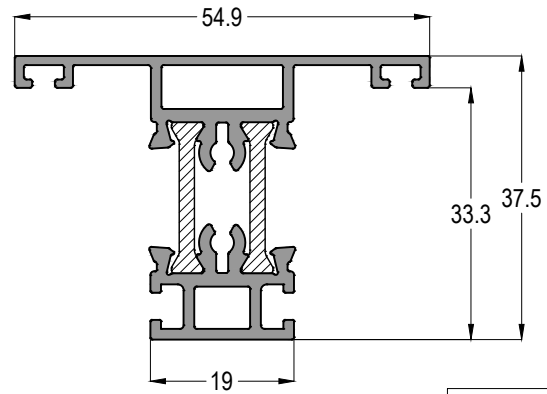

SL38T 21

0,904 kg/mt

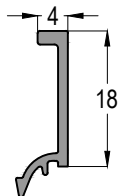

SL38T 20

0,391 kg/mt

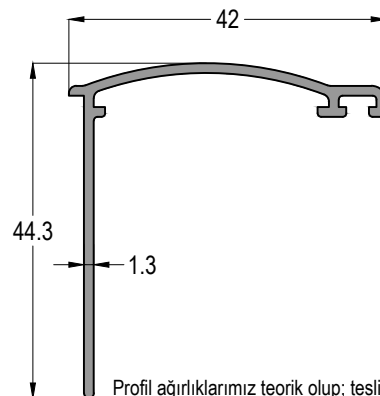

12-54

0,326 kg/mt



Profil ağırlıklarımız teorik olup; teslim anındaki tartımız geçerlidir.
Profile weights are theoretical and the weight at the time of delivery is valid.

SL38T-K

YALITIMLI KALDIR-SÜR SİSTEM
THERMAL LIFT&SLIDE SYSTEM



ASISTAL

15-304216-09

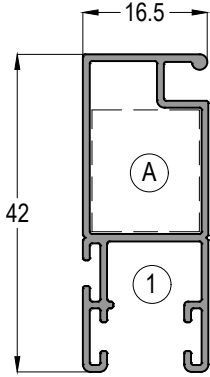
 ASI-BZ 5007	 ASI-BZ 5060	AĞIRLIK / Weight 0,352 kg/mt
---	--	---------------------------------



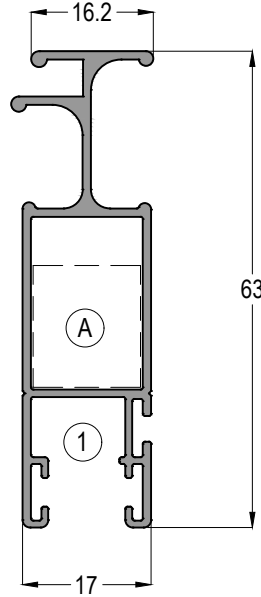

15-306317-11

 ASI-BZ 5007	 ASI-BZ 5060	AĞIRLIK / Weight 0,561 kg/mt
--	--	---------------------------------



13-09986

 ASI-PB 1119	 ASI-SR 01R	AĞIRLIK / Weight 0,741 kg/mt
--	---	---------------------------------

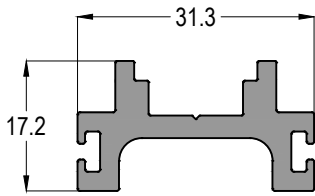
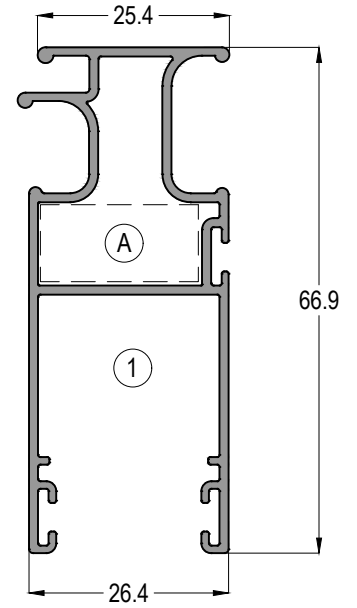

SL38T 44

0,560 kg/mt

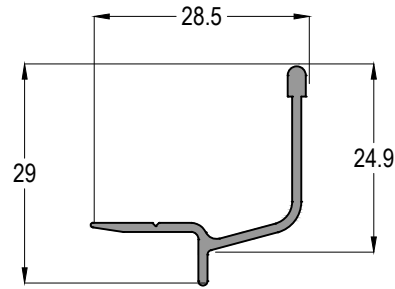

SL38T 61

0,185 kg/mt

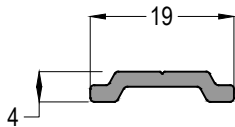

12-41

0,118 kg/mt

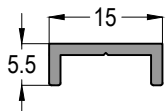

SL-1515

0,092 kg/mt

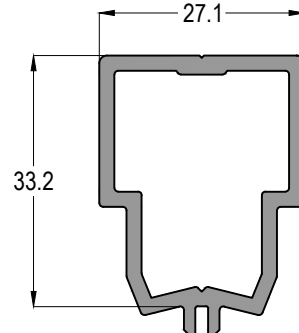

SL38T 35

0,651 kg/mt

Profil ağırlıklarımız teorik olup; teslim anındaki tartımız geçerlidir.
Profile weights are theoretical and the weight at the time of delivery is valid.

AÇILIM TIPLERİ KALDIR-SÜR SÜRME - OPENING TYPES LIFT & SLIDING

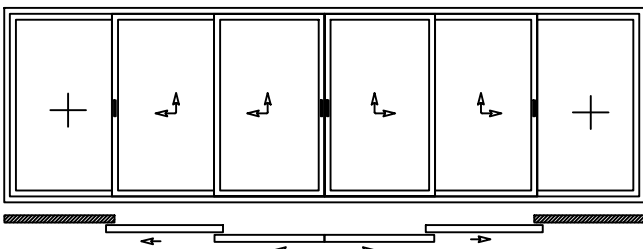
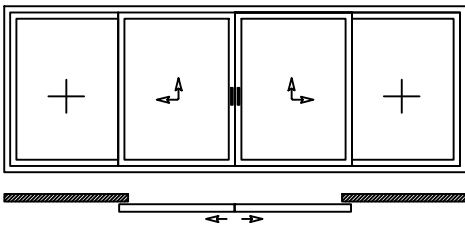
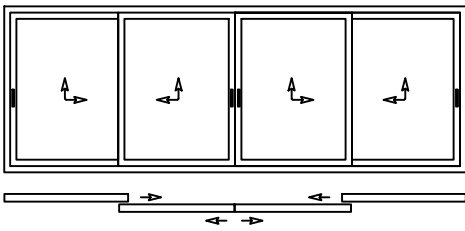
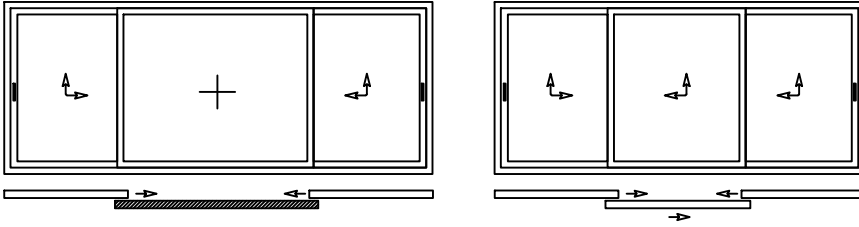
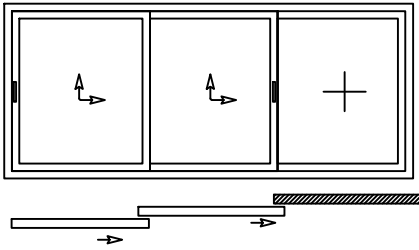
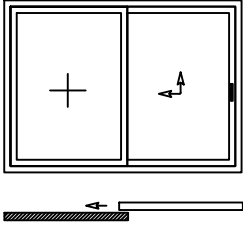
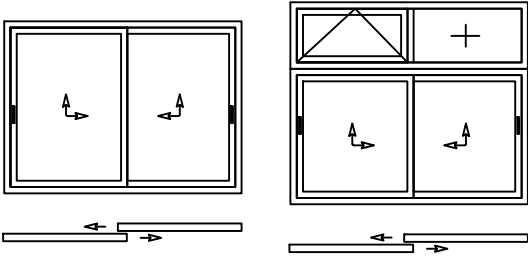

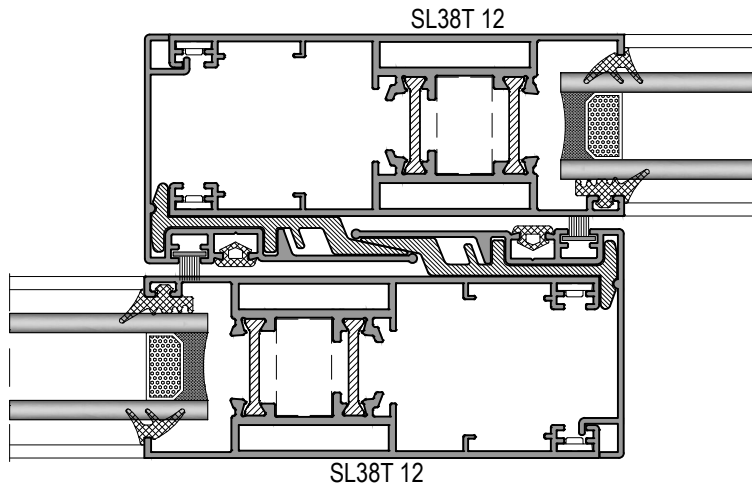
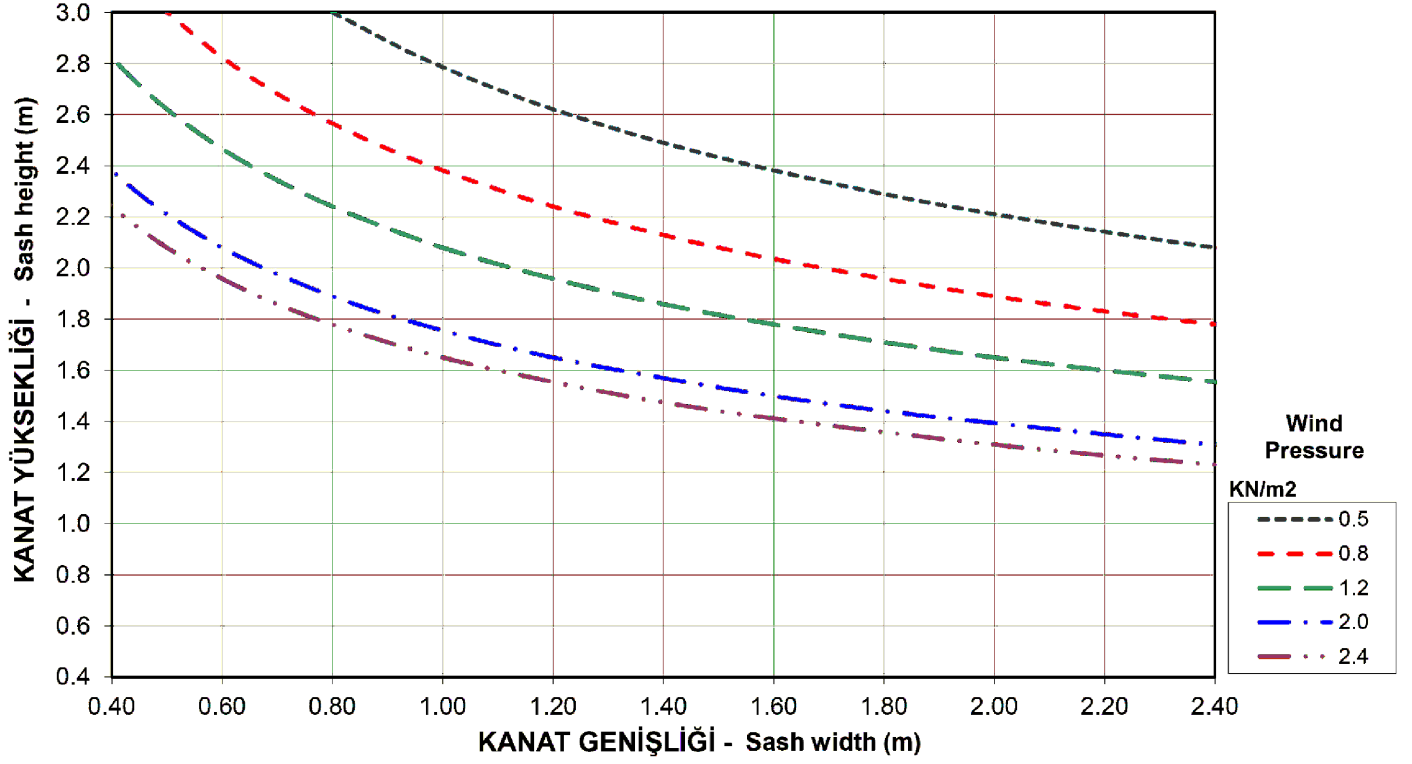
RÜZGAR YÜKÜNE GÖRE MAKSİMUM KANAT EBATLARI
MAXIMUM SASH DIMENSIONS FOR GIVEN WIND PRESSURE

KANAT EBATLARI BELİRLENİRKEN RULMANIN TAŞIMA KAPASİTESİNİ GEÇMEMESİNE DİKKAT EDİLMELİDİR
WHILE THE SASH SIZES ARE DETERMINED, SASH WEIGHT MUST BE LESS THAN ROLLER CARRY CAPACITY

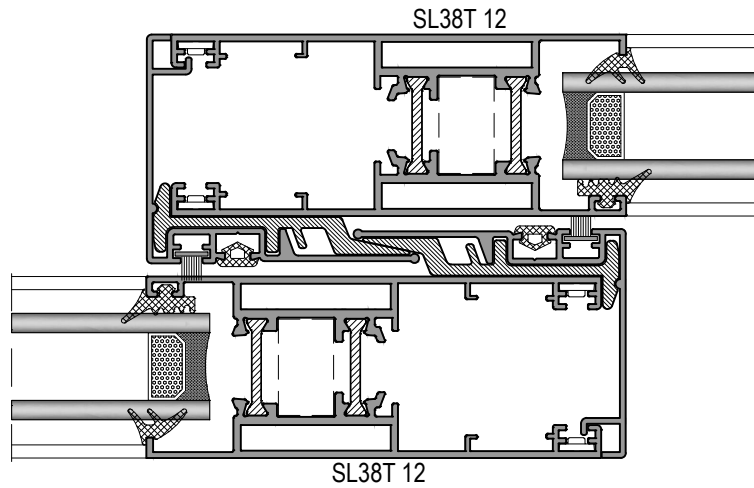
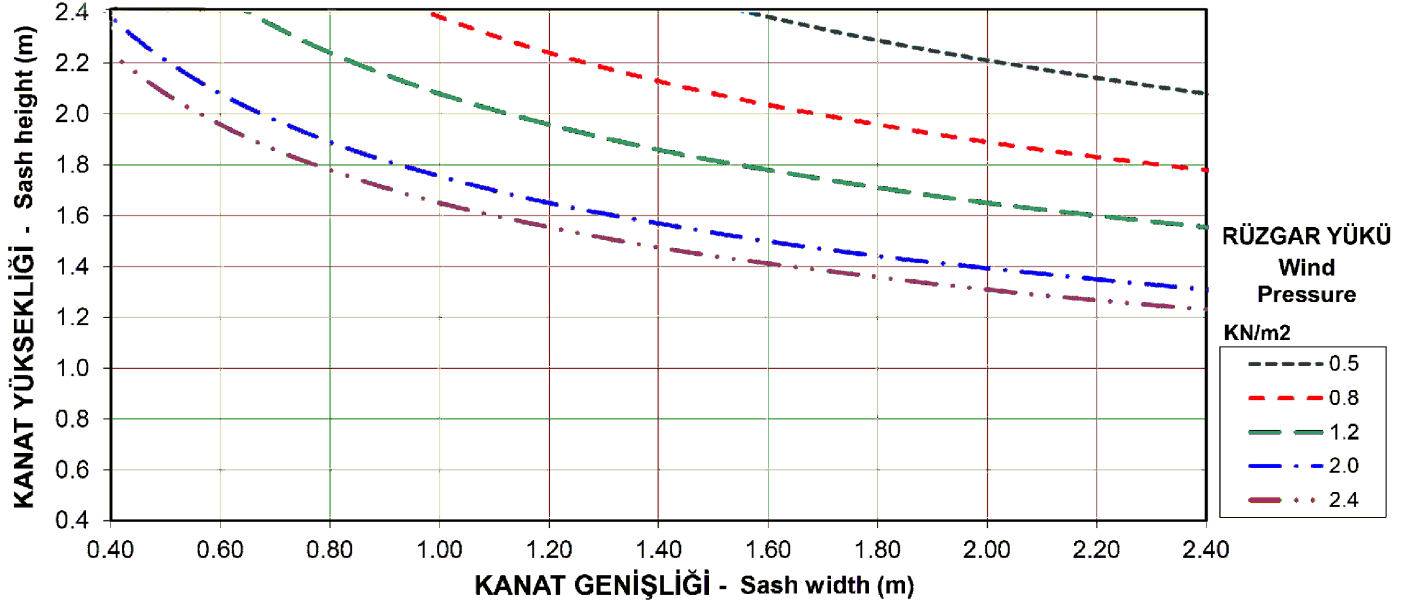
RÜZGAR YÜKÜNE GÖRE MAKSİMUM KANAT EBATLARI
MAXIMUM SASH DIMENSIONS FOR GIVEN WIND PRESSURE

KANAT EBATLARI BELİRLENİRKEN RULMANIN TAŞIMA KAPASİTESİNİ GEÇMEMESİNE DİKKAT EDİLMELİDİR
WHILE THE SASH SIZES ARE DETERMINED, SASH WEIGHT MUST BE LESS THAN ROLLER CARRY CAPACITY

SL38T - K

YALITIMLI KALDIR-SÜR SİSTEM
THERMAL LIFT&SLIDE SYSTEM

ASISTAL

SİSTEM DETAYLARI
SYSTEM DETAILS

SL38T-K

YALITIMLI KALDIR-SÜR SİSTEM
THERMAL LIFT&SLIDE SYSTEM

ASISTAL

KALDIR-SÜR DETAYLARI LIFT & SLIDE DETAILS

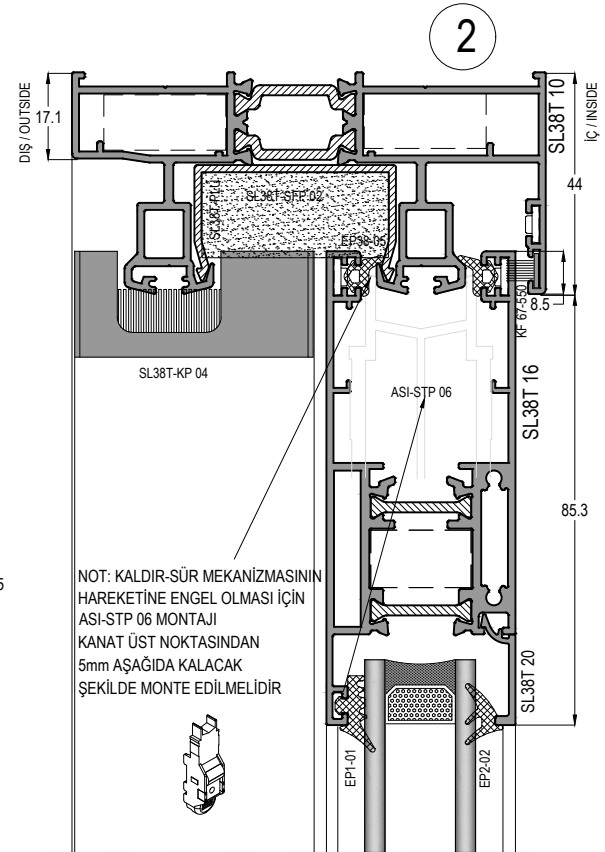
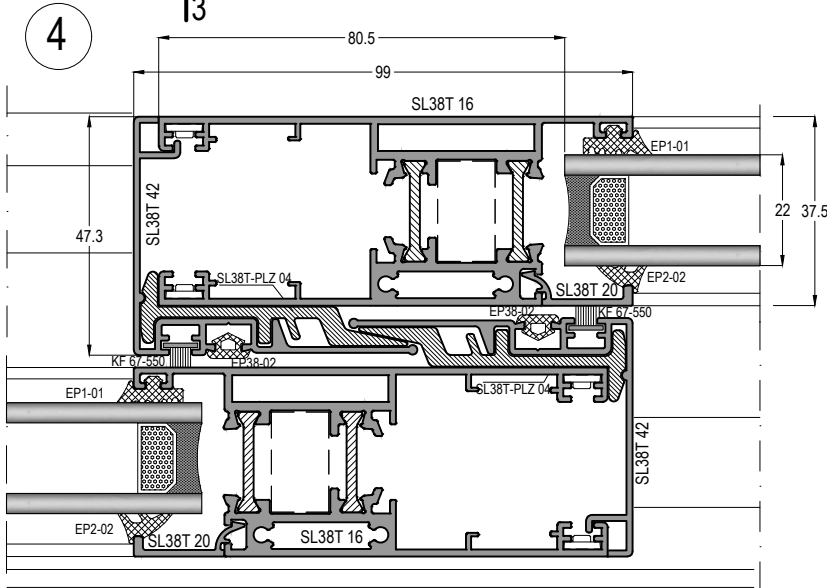
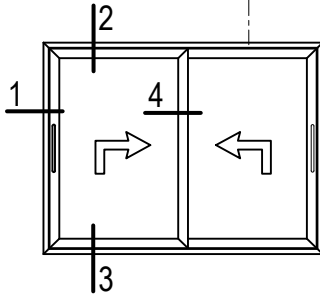
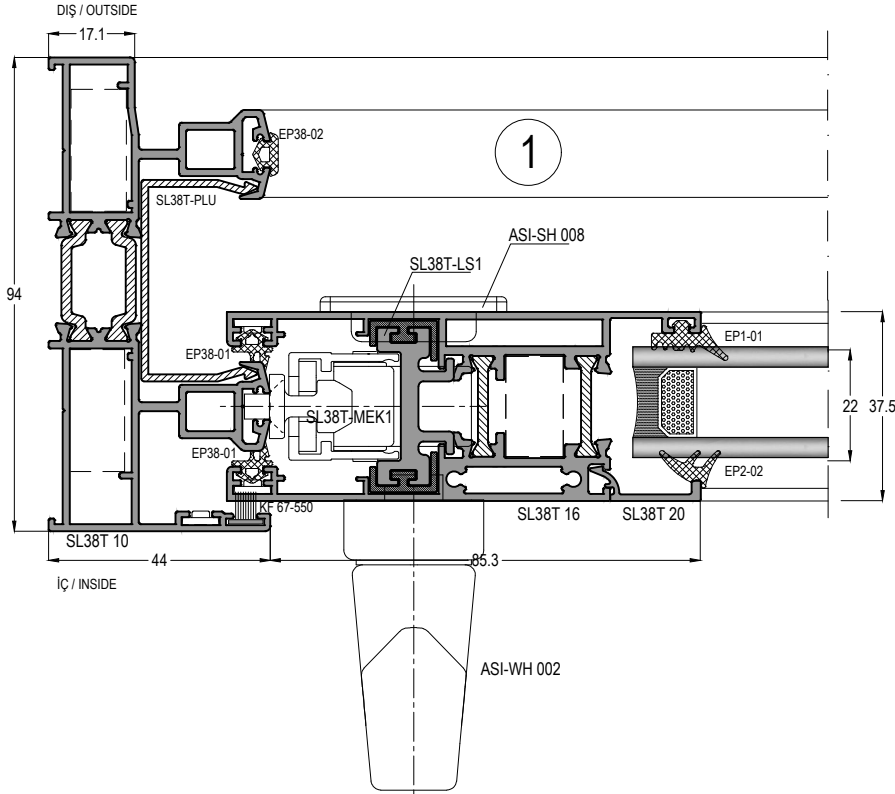

NOT: KALDIR-SÜR MEKANİZMASININ
HAREKETİNE ENGEL OLMASI İÇİN
ASI-STP 06 MONTAJI
KANAT ÜST NOKTASINDAN
5mm AŞAĞIDA KALACAK
ŞEKİLDE MONTE EDİLMELİDİR

NOTE:
ASI-STP 06 INSTALLATION SHOULD BE MOUNTED TO
BE 5mm DOWN FROM THE TOP POINT OF THE SASH
TO PREVENT THE MOVEMENT OF THE LIFT&SLIDE
MECHANISM.

3

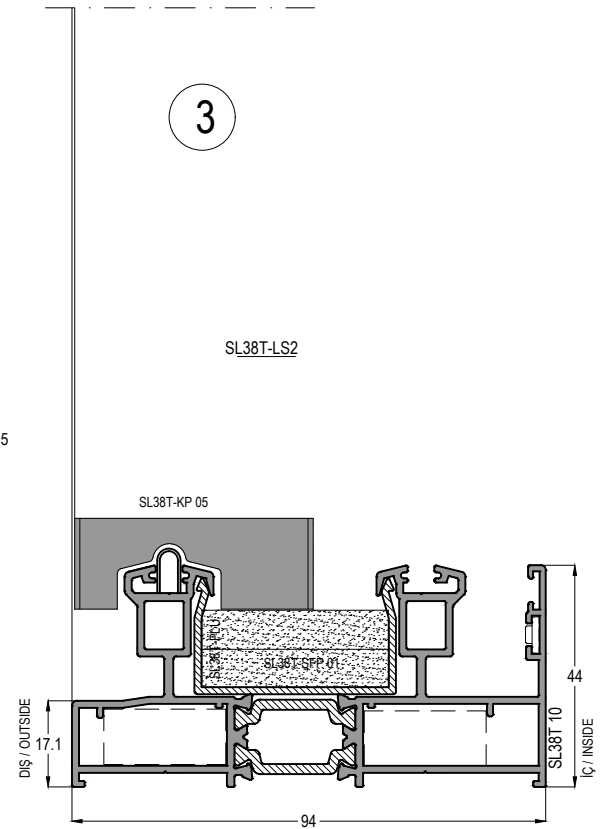

SL38T-K

YALITIMLI KALDIR-SÜR SİSTEM
THERMAL LIFT&SLIDE SYSTEM



3a

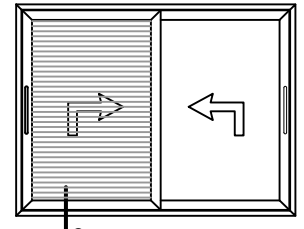
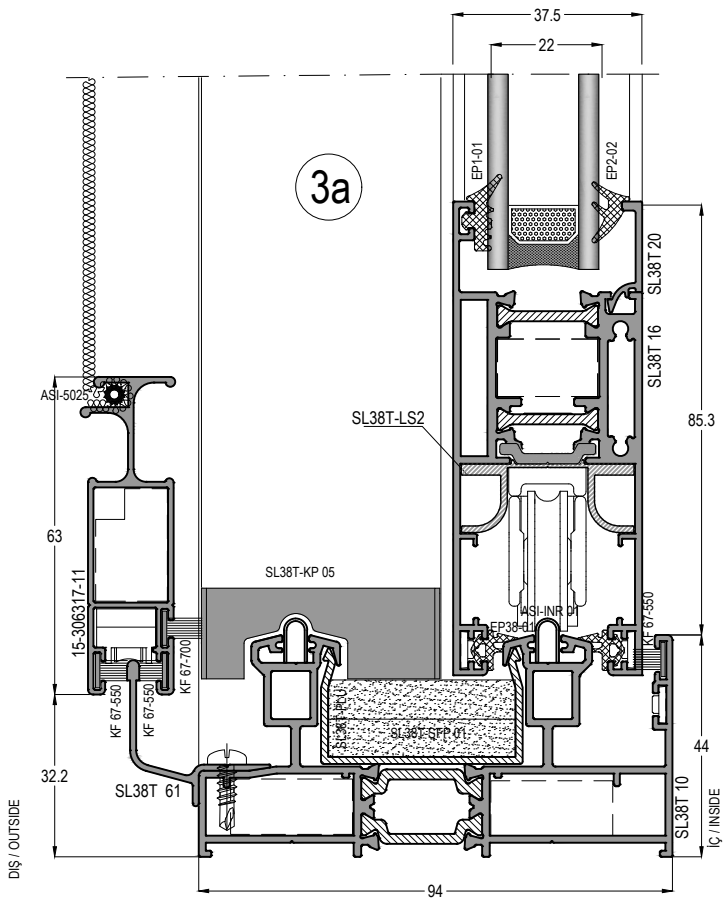

3a
3b

3b

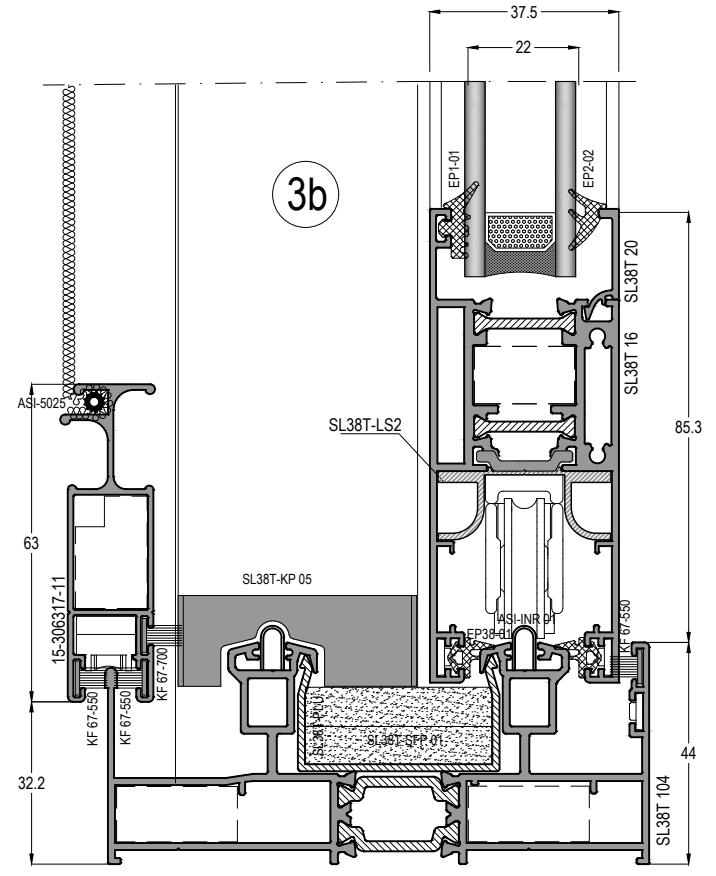

3c

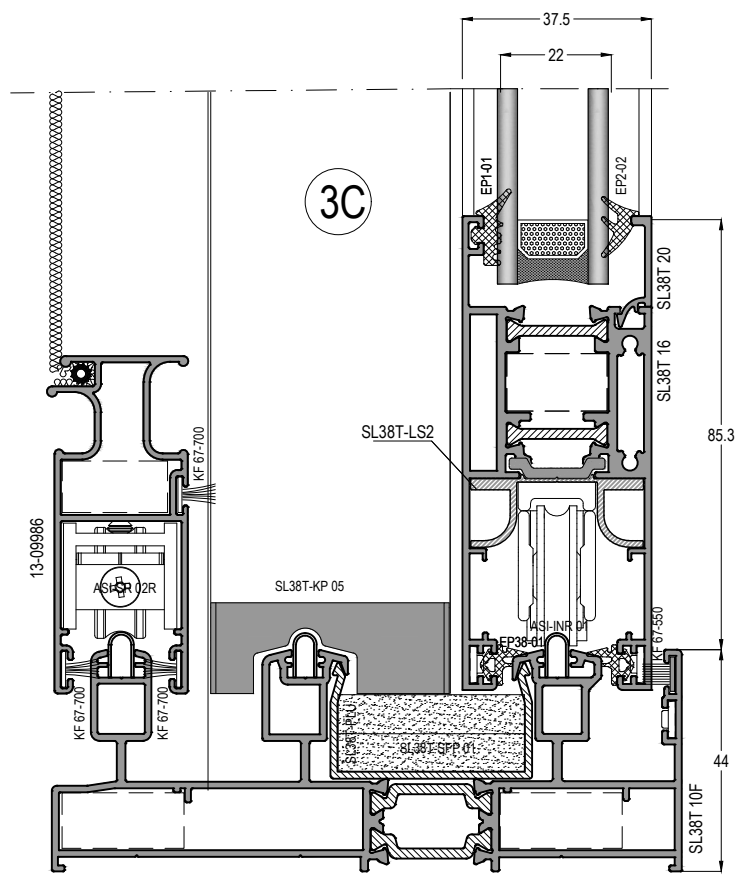

SL38T-K

YALITIMLI KALDIR-SÜR SİSTEM
THERMAL LIFT&SLIDE SYSTEM

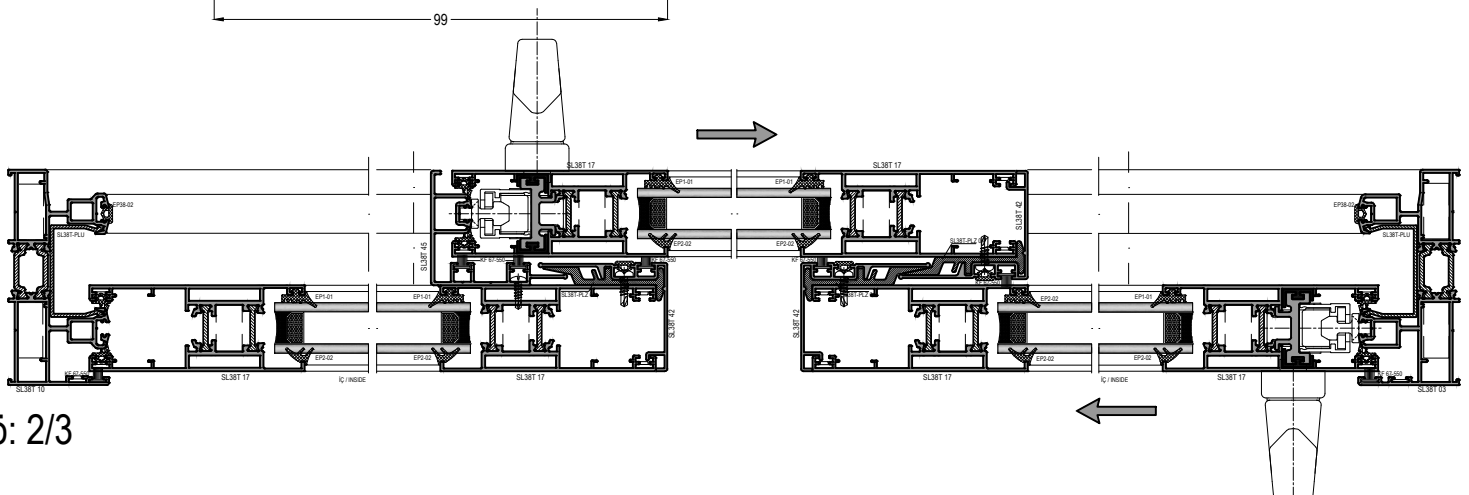
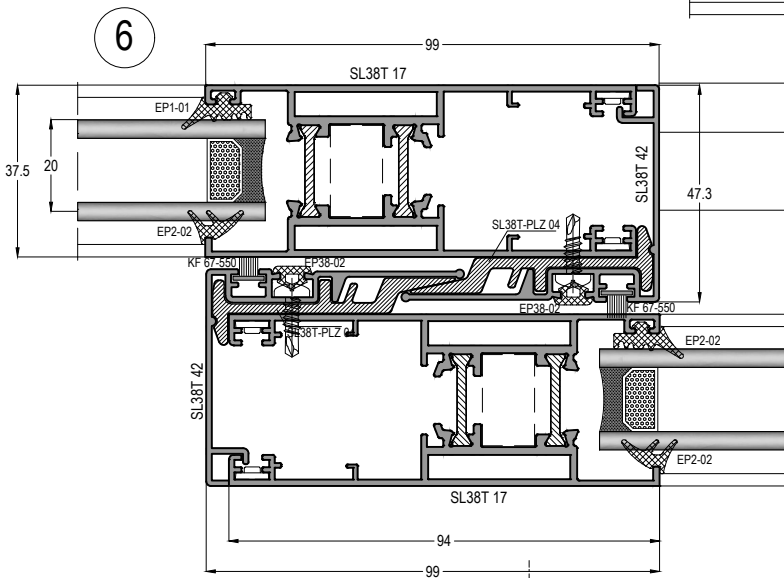
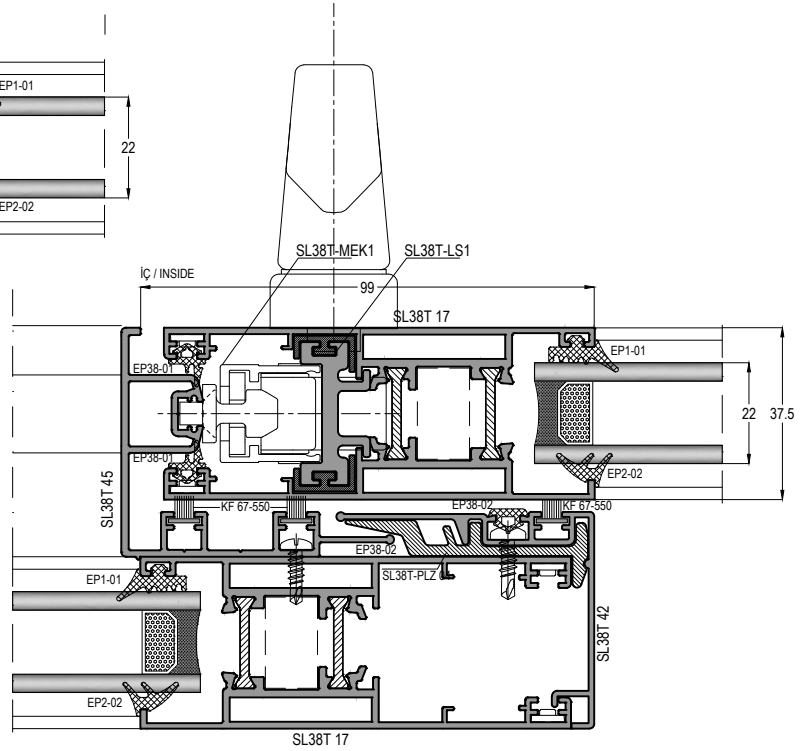
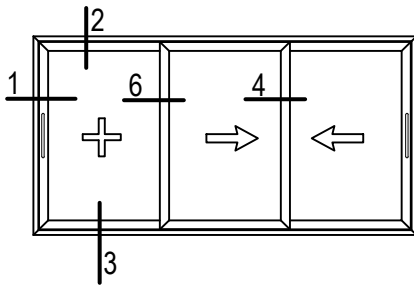
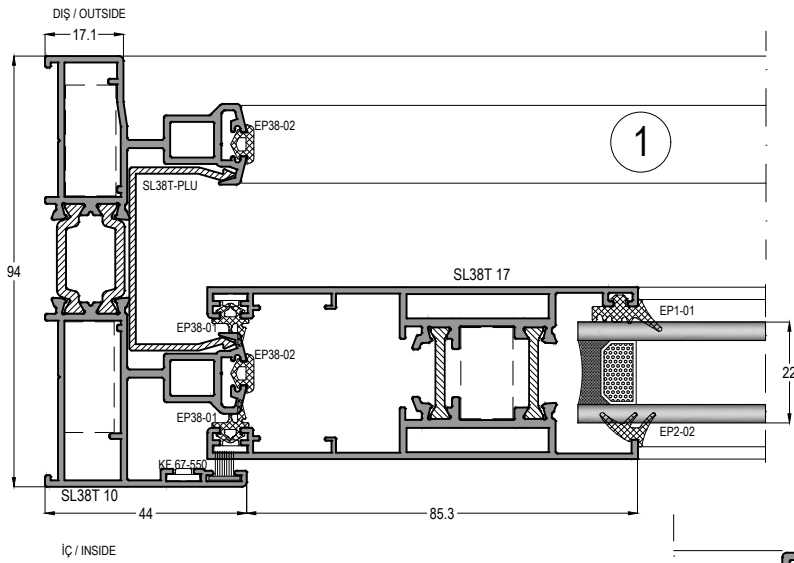

SL38T-K

YALITIMLI KALDIR-SÜR SİSTEM
THERMAL LIFT&SLIDE SYSTEM



KALDIR-SÜR DETAYLARI LIFT & SLIDE DETAILS

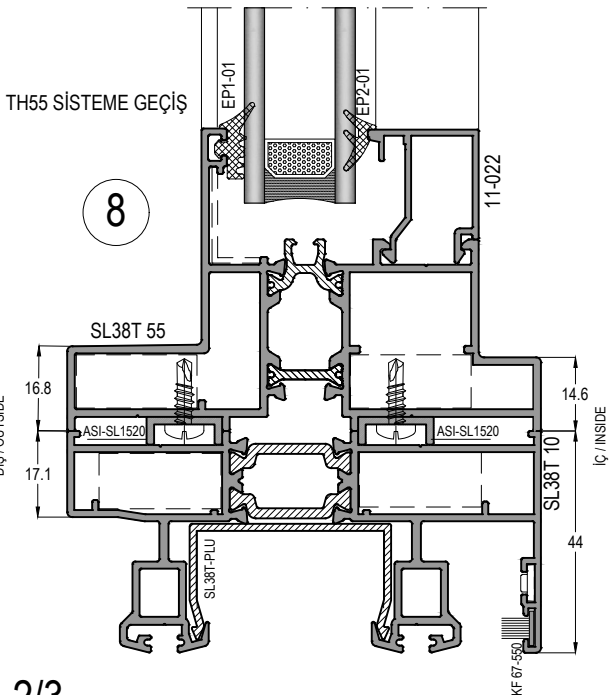
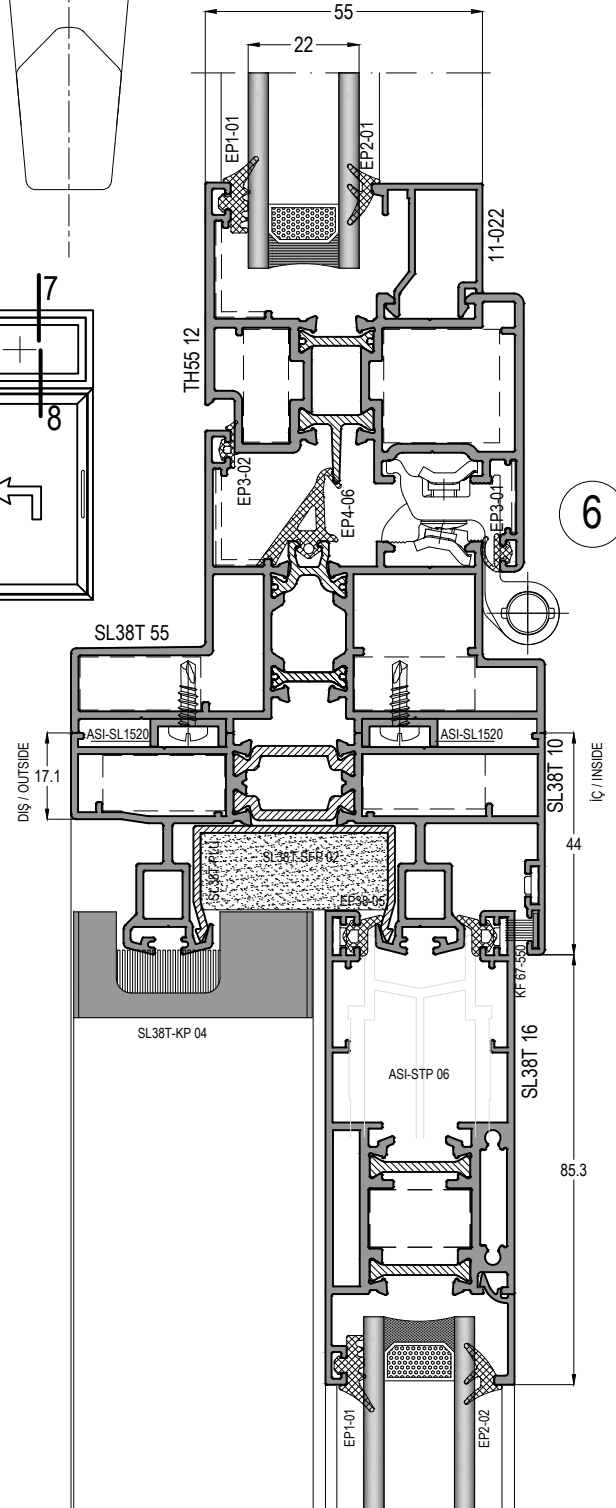
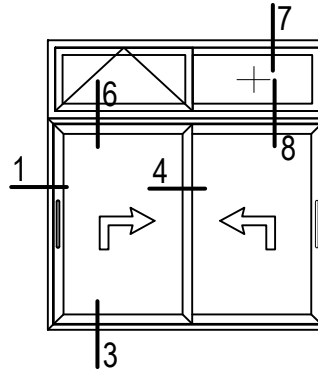
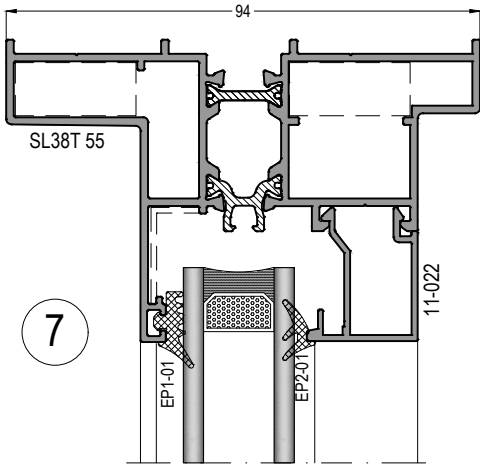
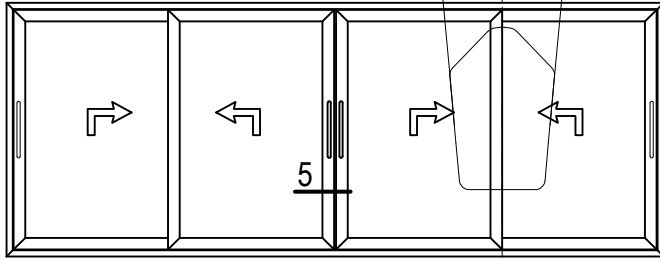
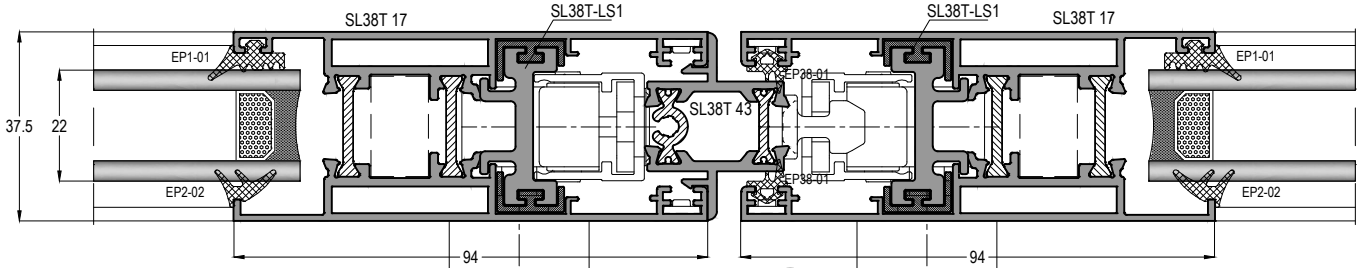

SL38T-K

YALITIMLI KALDIR-SÜR SİSTEM
THERMAL LIFT&SLIDE SYSTEM



KALDIR-SÜR DETAYLARI LIFT & SLIDE DETAILS

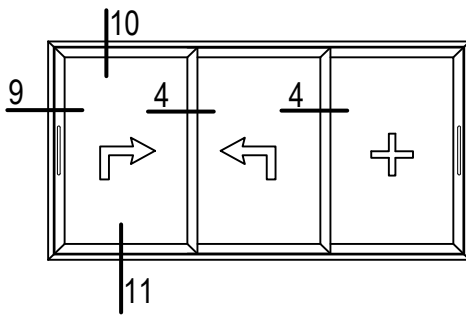
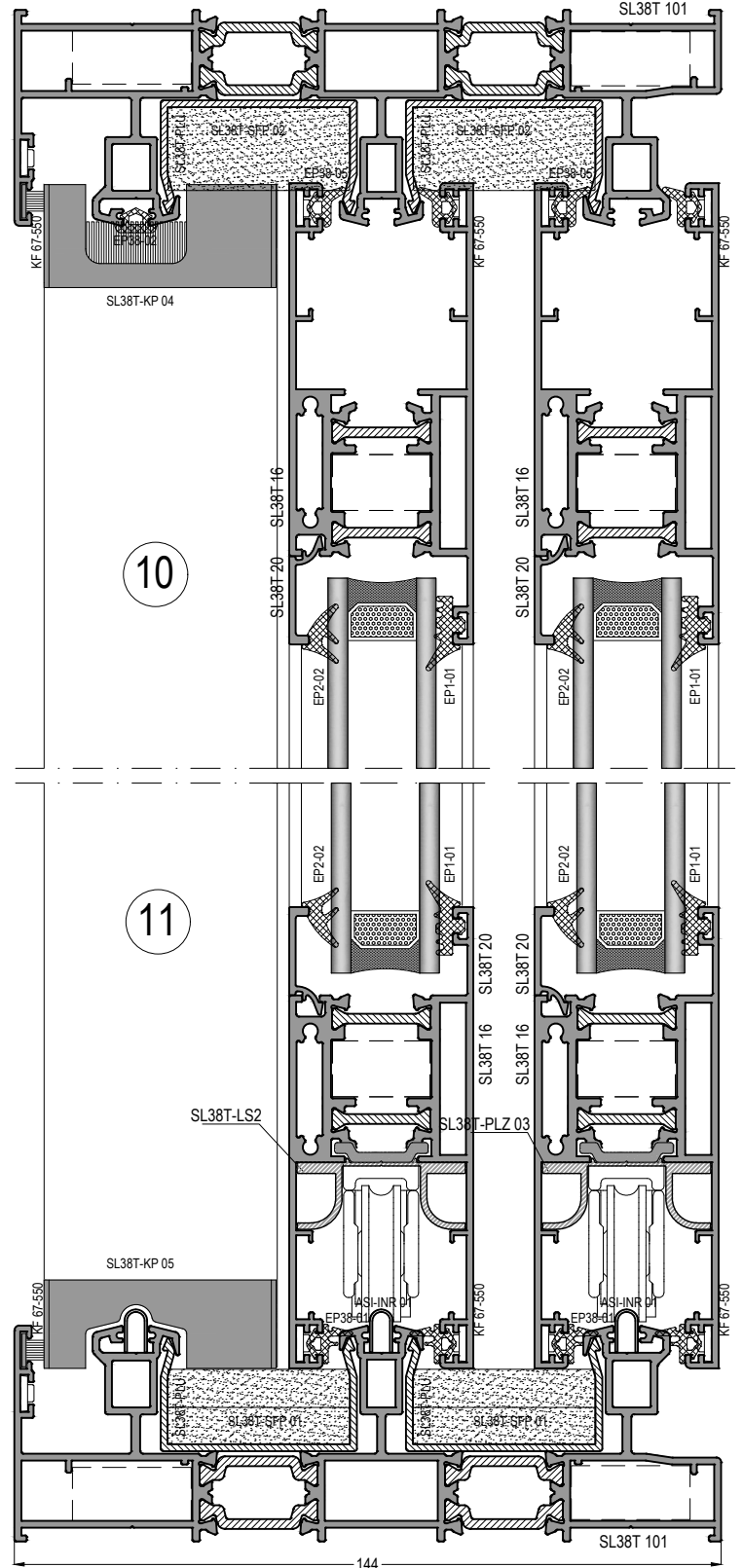
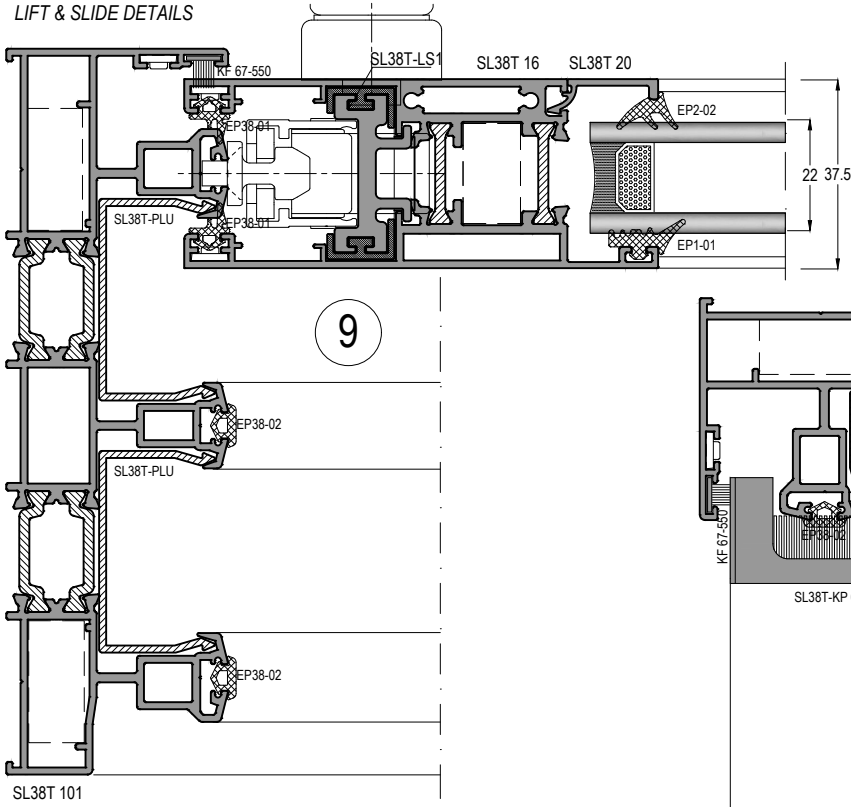

SL38T-K

YALITIMLI KALDIR-SÜR SİSTEM
THERMAL LIFT&SLIDE SYSTEM



KALDIR-SÜR DETAYLARI LIFT & SLIDE DETAILS

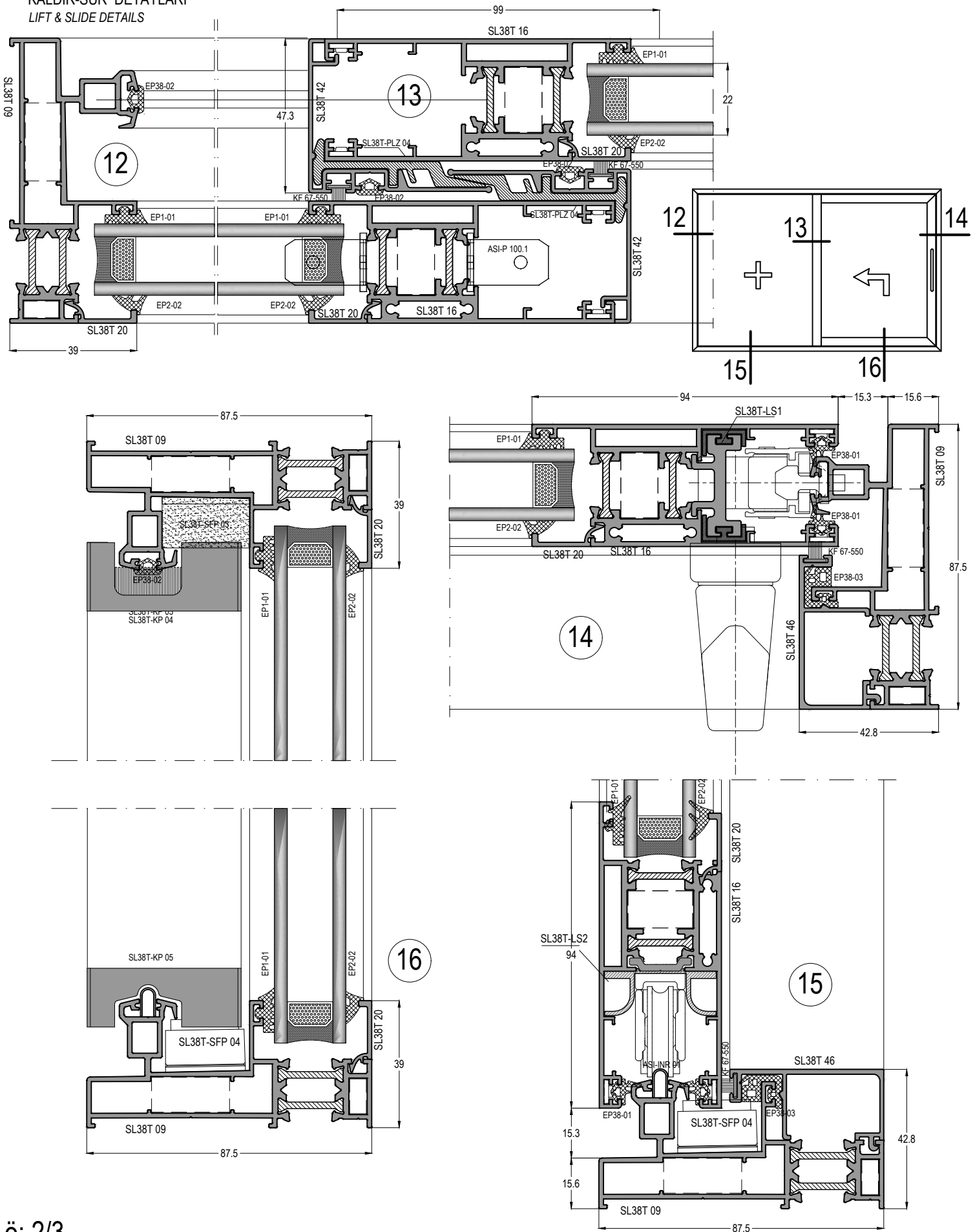



TH55 SİSTEME GEÇİŞ DETAYLARI DETAILS FOR TH55 SYSTEM JOINT

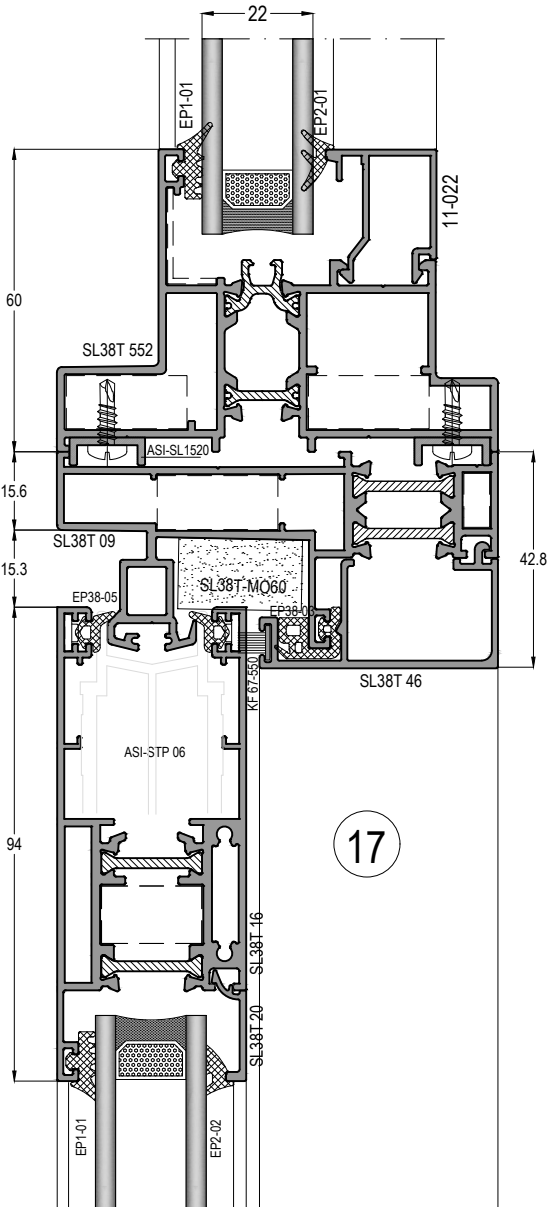
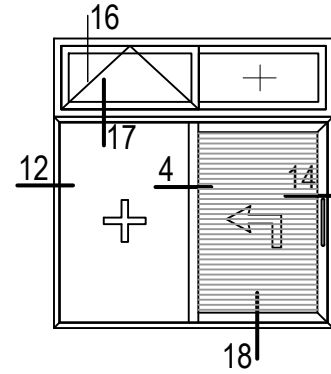
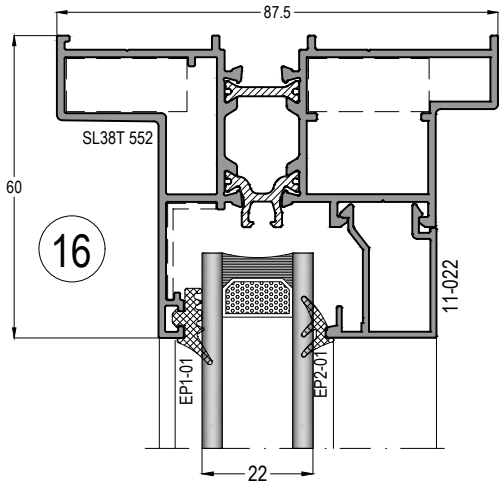

18

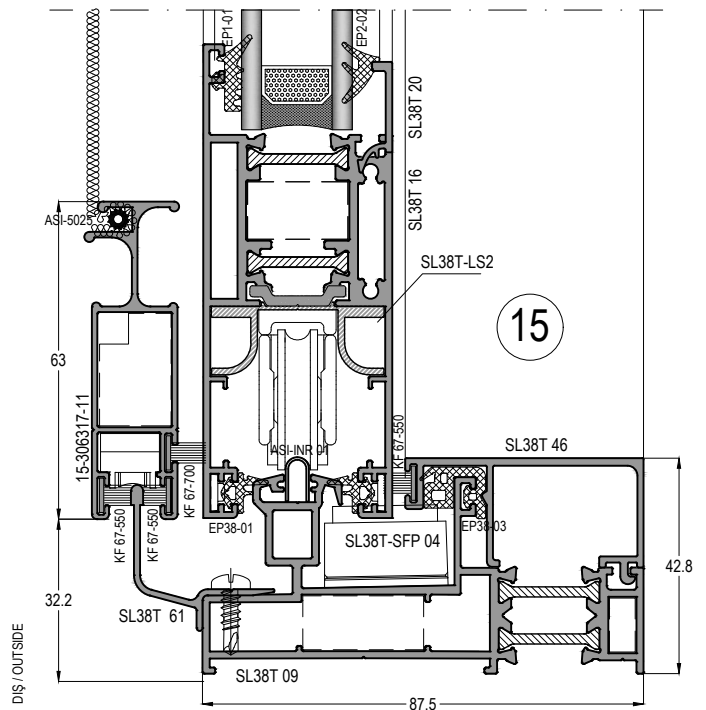

SL38T-K

YALITIMLI KALDIR-SÜR SİSTEM
THERMAL LIFT&SLIDE SYSTEM

ASISTAL

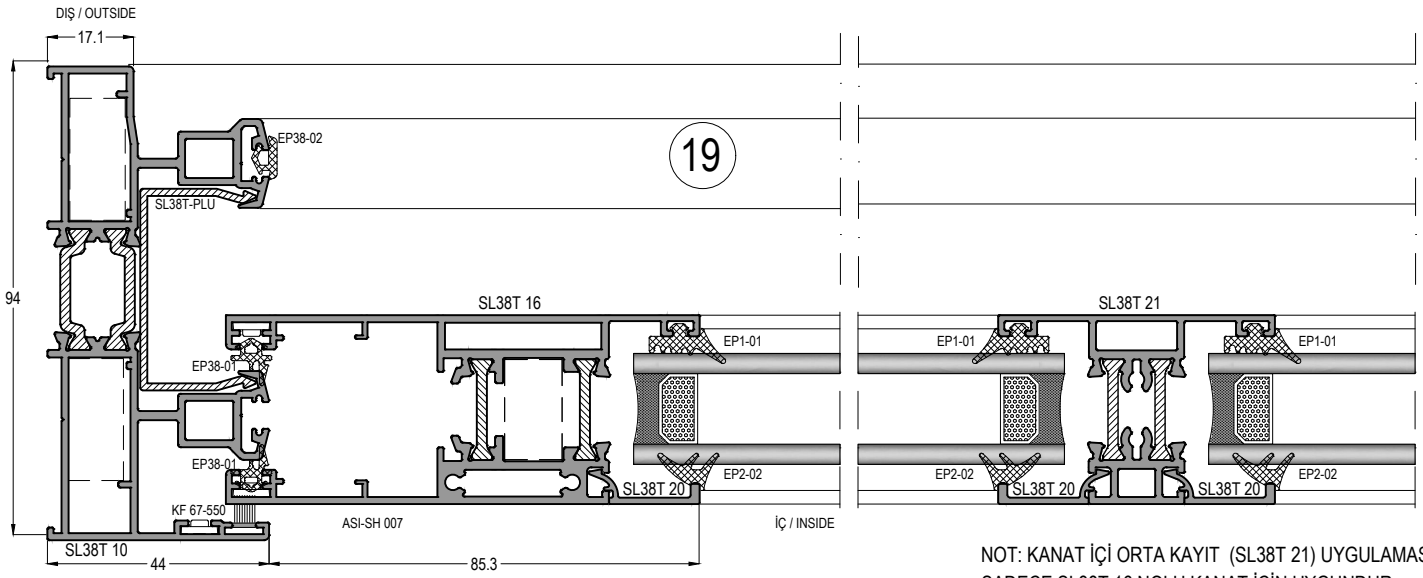

NOT: KANAT İÇİ ORTA KAYIT (SL38T 21) UYGULAMASI SADECE SL38T 16 NOLU KANAT İÇİN UYGUNDUR.
SL38T 21 Mullion / Transom profile works with only SL38T 16 sash profile

